

# DIMENSIONAMENTO EM ARQUITETURA

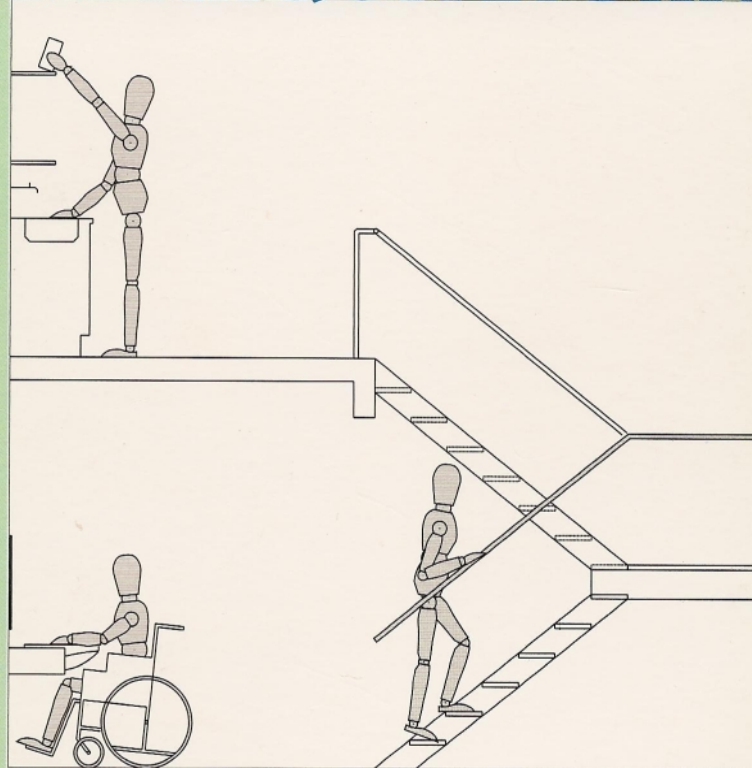

**emile pronk**





# DIMENSIONAMENTO EM ARQUITETURA

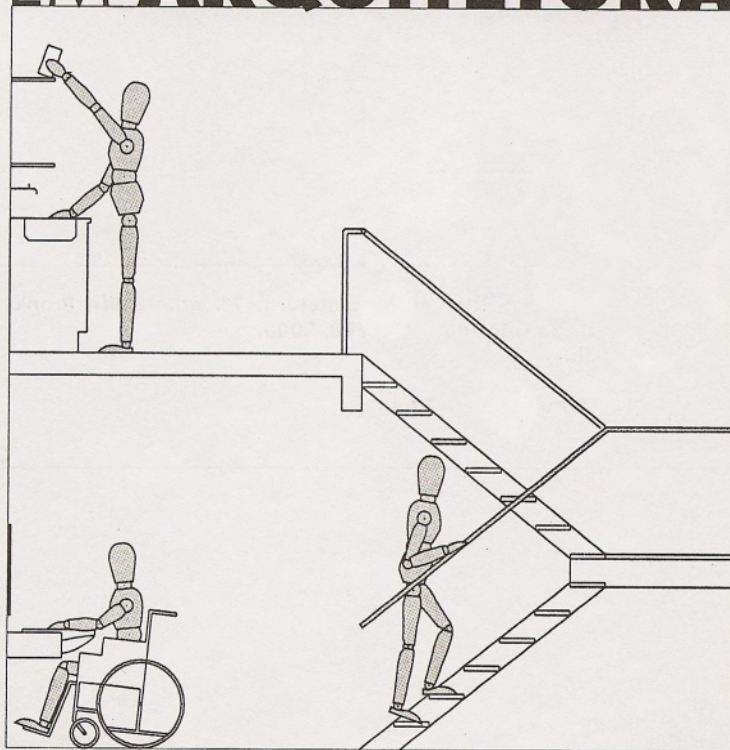





**UNIVERSIDADE FEDERAL DA PARAÍBA**

**Reitor**

**JADER NUNES DE OLIVEIRA**

**Vice-Reitor**

**MÚCIO ANTÔNIO SOBREIRA SOUTO**



**EDITORA UNIVERSITÁRIA**

**Conselho Editorial**

**JOSÉ DAVID CAMPOS FERNANDES (Presidente)**

**JOSÉ LUIZ DA SILVA**

**JOSÉ VITALIANO DE C. ROCHA FILHO**

**MANOEL ALEXANDRE CAVALCANTE BELO**

**MARCILIA LUIZA G. DA COSTA**

**JAQUELINE CRISTINA DA C. MOTA**

**SÉRGIO DE CASTRO PINTO**

**Diretor**

**JOSÉ DAVID CAMPOS FERNANDES**

**Vice-diretor**

**JOSÉ LUIZ DA SILVA**

**Divisão de Produção**

**JOSÉ AUGUSTO DOS SANTOS FILHO**

**Divisão de Editoração**

**ALMIR CORREIA DE VASCONCELLOS**

**Secretário**

**MARINÉSIO CÂNDIDO DA SILVA**



**emile pronk**

# **DIMENSIONAMENTO EM ARQUITETURA**

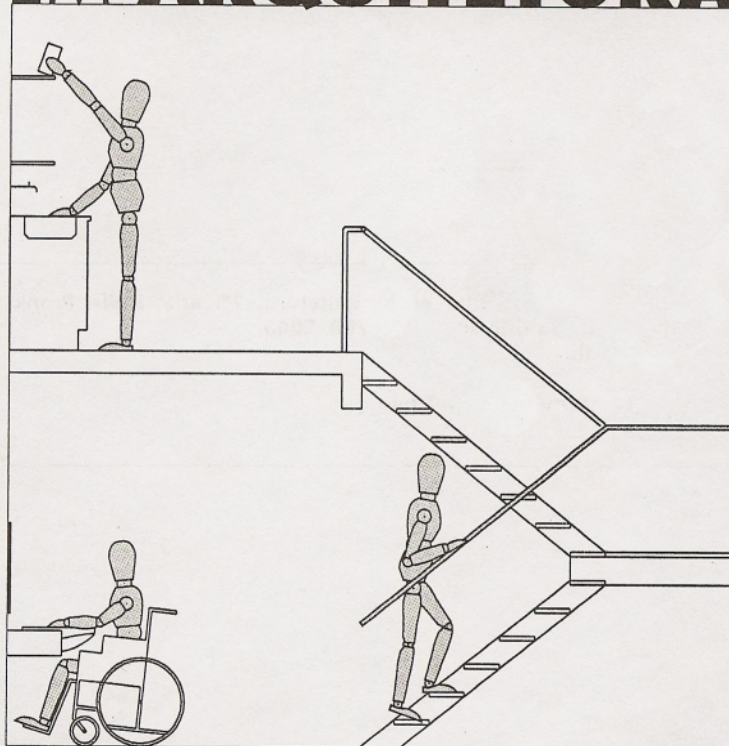

**7ª edição**



**Editora Universitária  
João Pessoa  
2003**

© Copyright by Emile Pronk, 2001

---

P965d

Pronk, Emile.

Dimensionamento em Arquitetura, 7ª. ed./ Emile Pronk - João  
Pessoa: Editora Universitária/UFPB, 2003.  
56p.il.

1. Arquitetura I. Título

---

UFPB/BC

CDU: 72

Direitos desta edição reservados à:

UFPB/EDITORA UNIVERSITÁRIA Caixa Postal 5081 - Cidade Universitária - João Pessoa - Paraíba - Brasil

CEP 58.051-970 - [www.editora.ufpb.br](http://www.editora.ufpb.br)

Impresso no Brasil

Printed in Brazil

Foi feito do depósito legal.

01 estar . . . . .	1-5
02 jantar. . . . .	6-9
03 cozinha . . . . .	10-13
04 serviço . . . . .	14-15
05 banheiro . . . . .	16-17
06 quarto . . . . .	18-19
07 garagem . . . . .	20-23
08 escada e rampa . . . . .	24-35
09 diversos . . . . .	36-37
10 dimensões do corpo . . . . .	38-39
11 adaptações para usuários de cadeira de rodas . . . . .	40-55





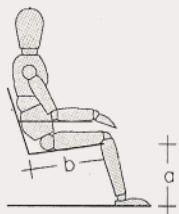

a 40,5  
b 50  
c 33,5  
d 45  
e 14  
f 55

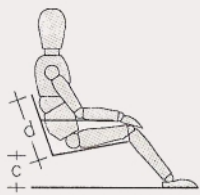

a 30  
b 51  
c 21  
d 42  
e 14  
f 44

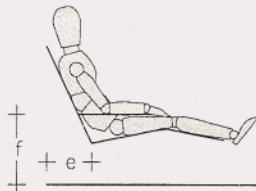

a 37  
b 50  
c 27  
d 70  
e 30  
f 46  
g 29  
h 40

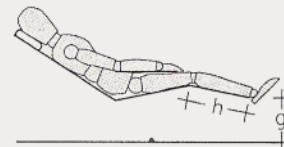

a 37  
b 50  
c 27  
d 80  
e 67,5  
f 46  
g 29  
h 40

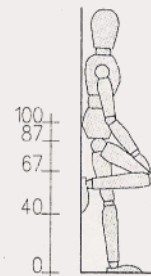
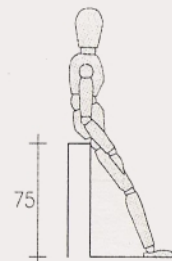
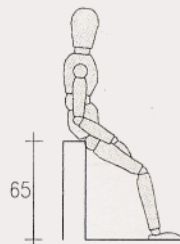
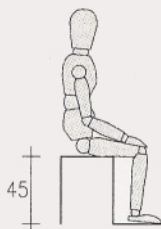
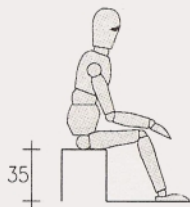
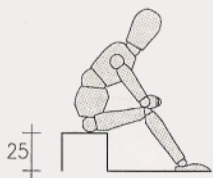

a 41  
b 45  
c 39  
d 35  
e 6

a 41  
b 47  
c 38  
d 39  
e 7

a 37  
b 51  
c 32  
d 50  
e 13

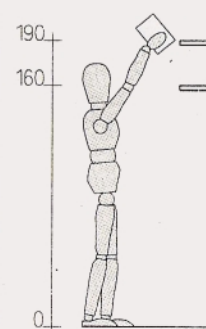
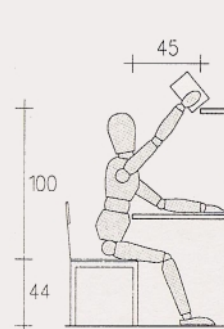
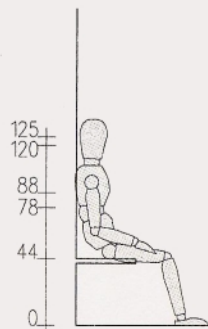
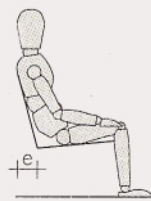
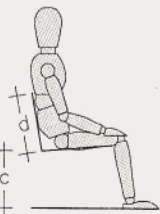
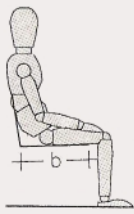

01 estar

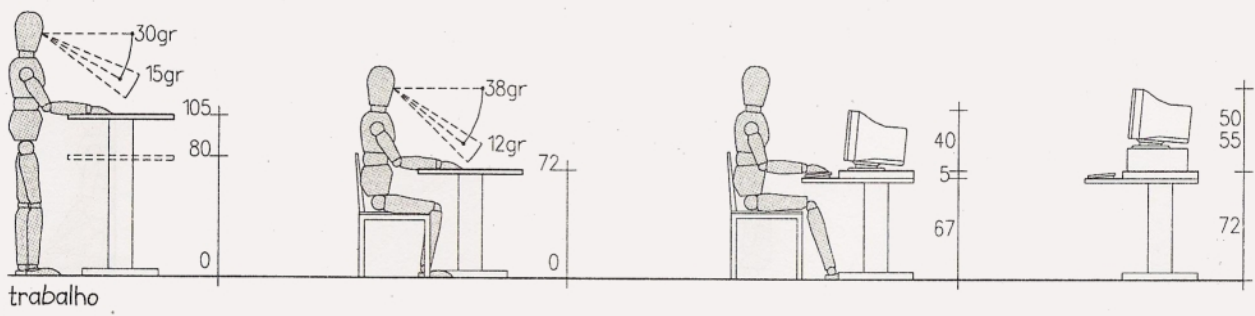
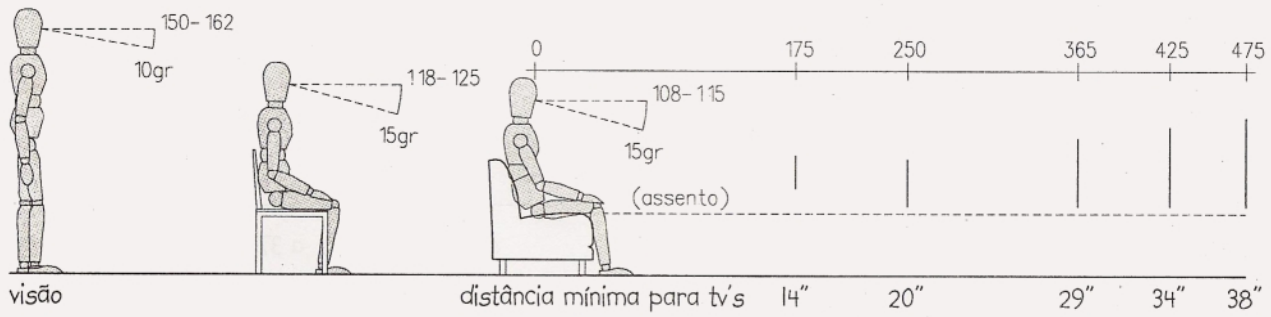



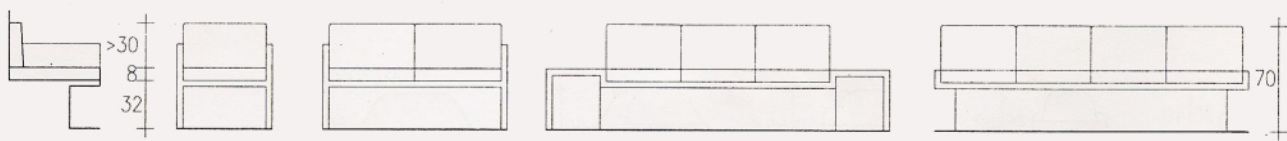
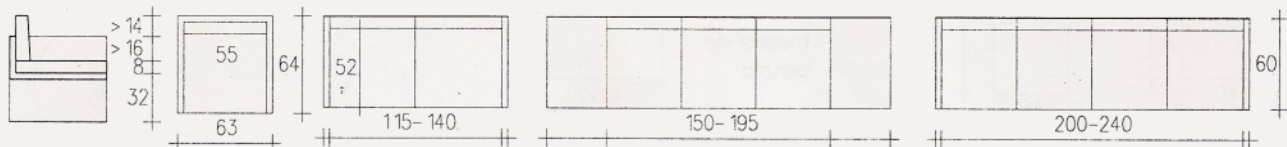

bancos em alvenaria c/almofada de 8cm., altura 40cm.

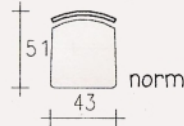
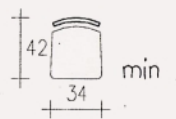
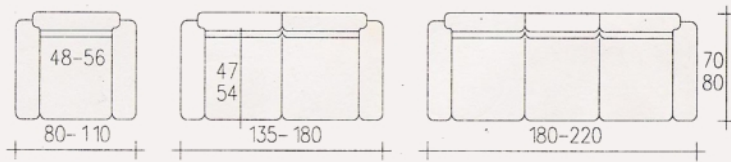
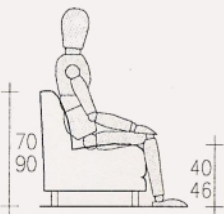

poltronas e sofás comerciais

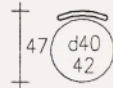
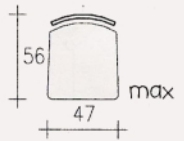
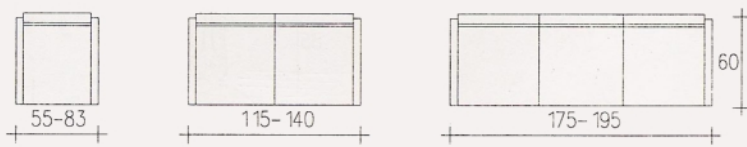
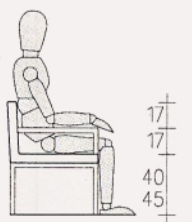

No sentar, mudanças frequentes de posição são importantes; uma boa cadeira deve permitir isso.

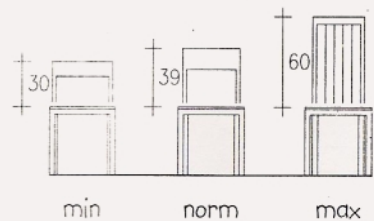
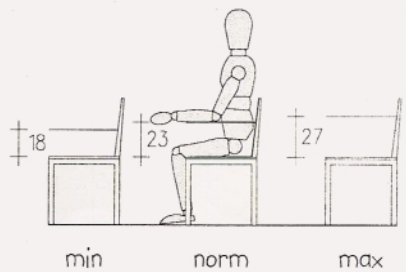
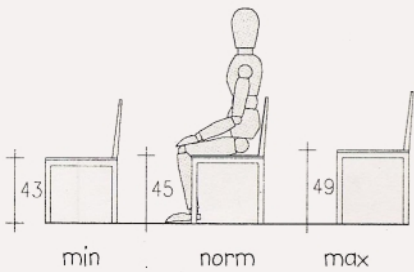

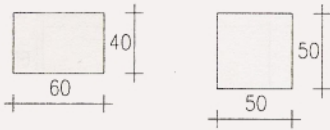

mesas de canto

mesas de centro

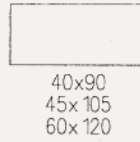

90x90

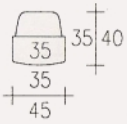
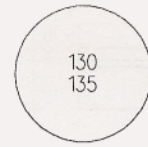

tv 14"

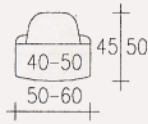

tv 20"

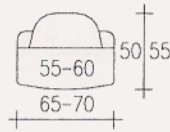

tv 29"

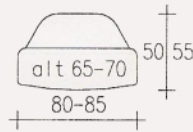

tv 34"

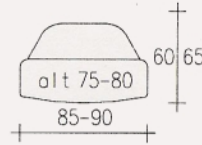

tv 38"

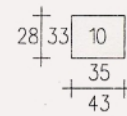

videocassete

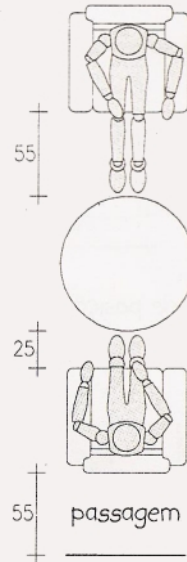
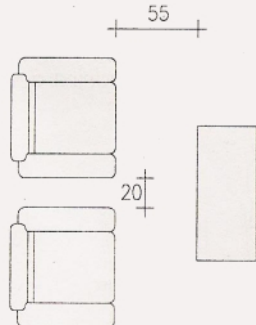
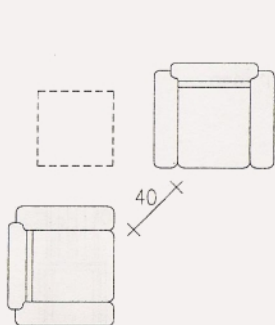
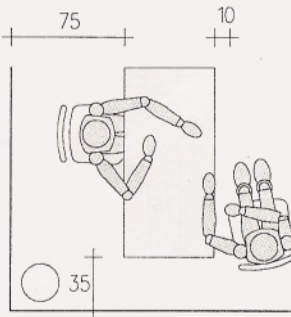

passagem

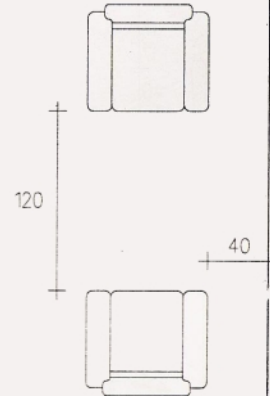

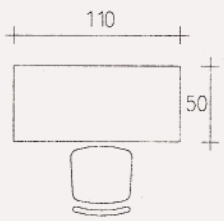

mesas de trabalho

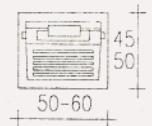
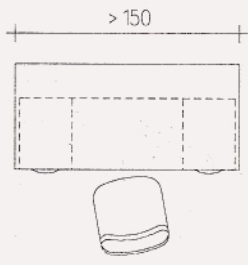
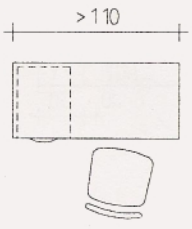
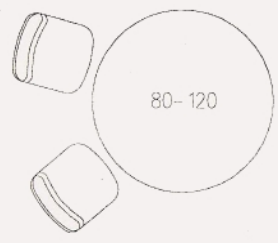
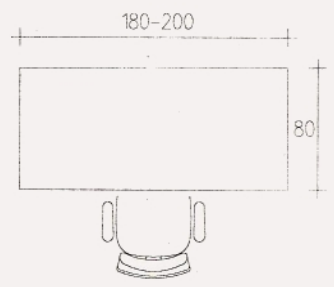
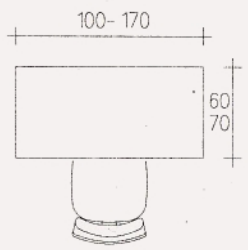

mesa maq. escr.

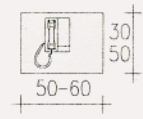

mesa telefone

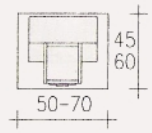

mesa impressora

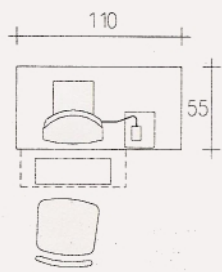
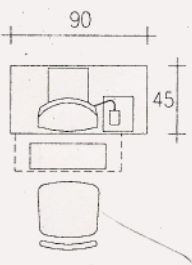
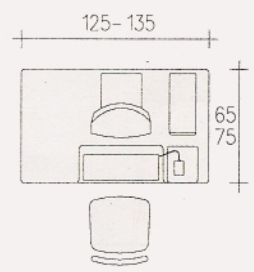
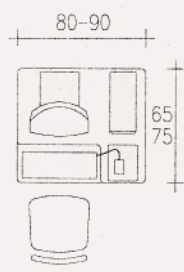
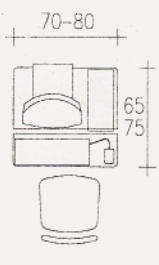
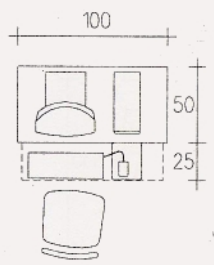
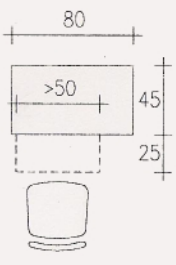

rack p/ computador

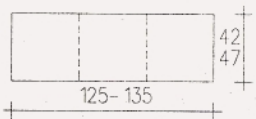
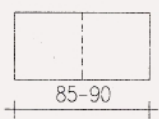
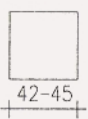

armários

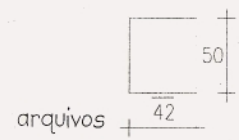

arquivos

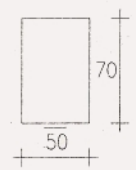



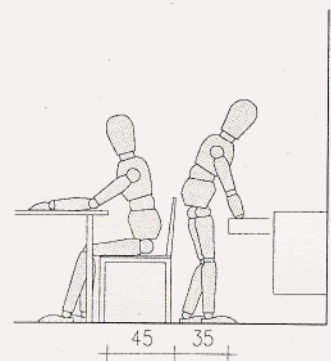
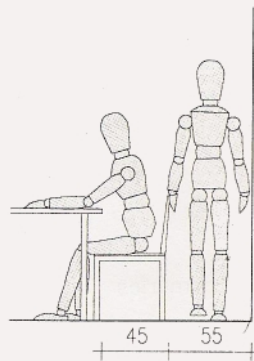
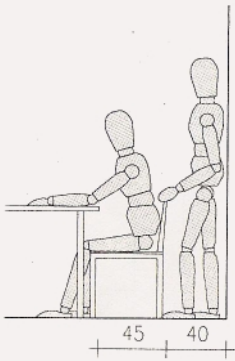
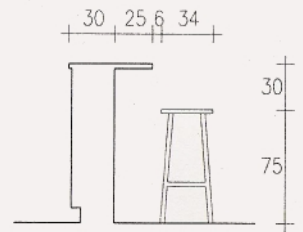
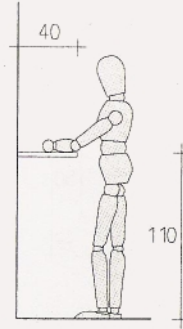
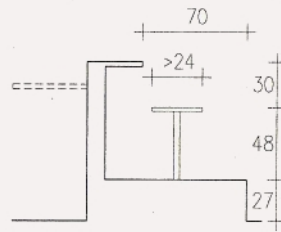
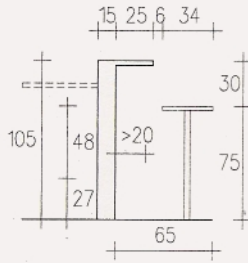
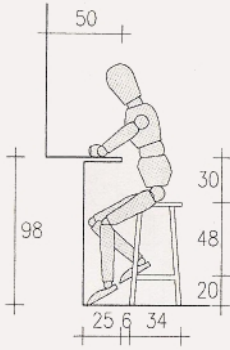
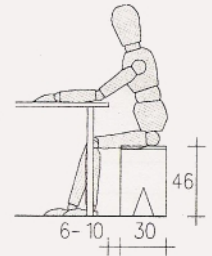
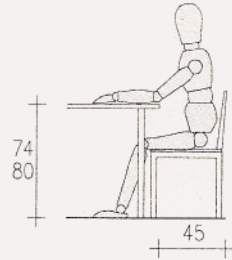
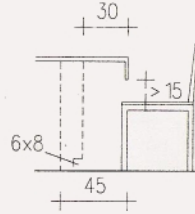
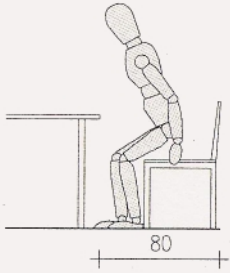

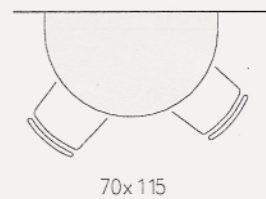
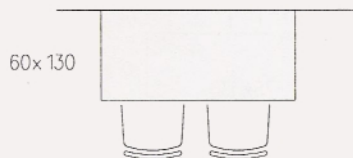
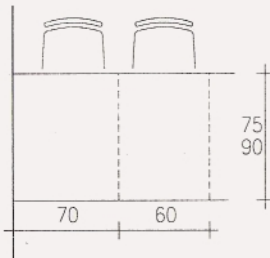
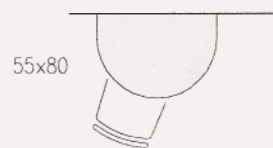
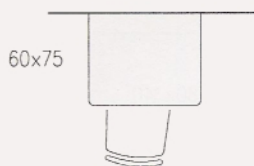
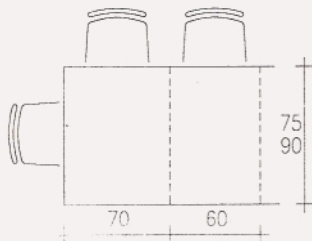
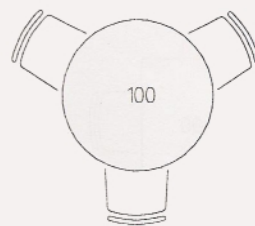
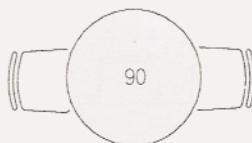
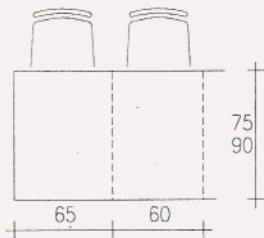
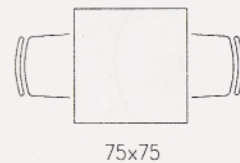
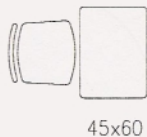
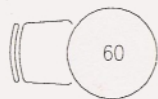
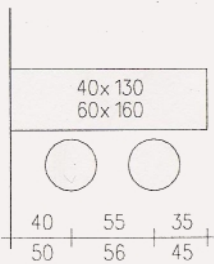

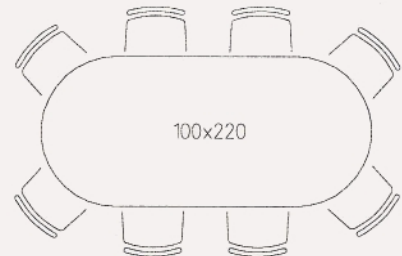
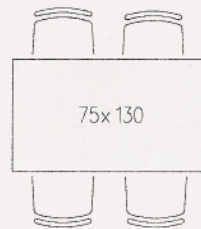
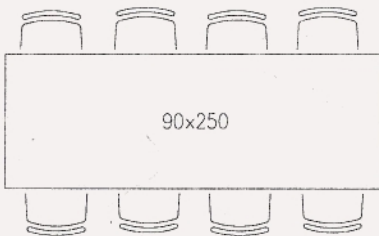
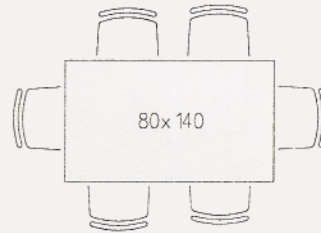
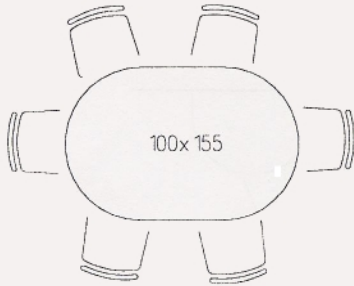
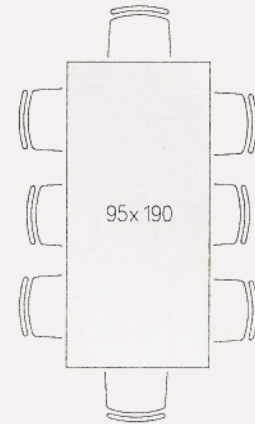
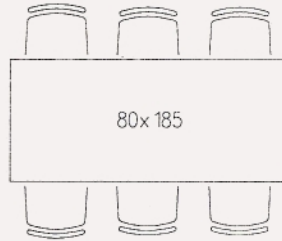
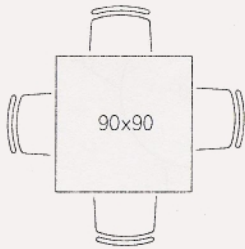
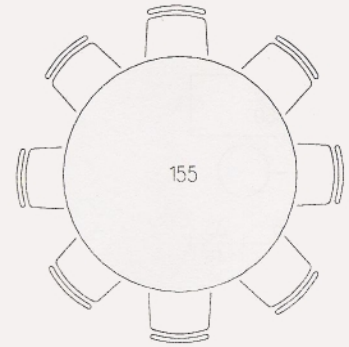
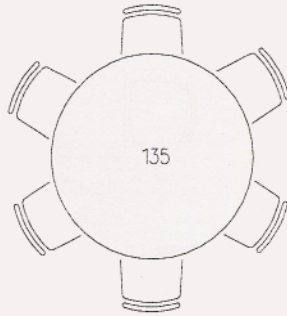
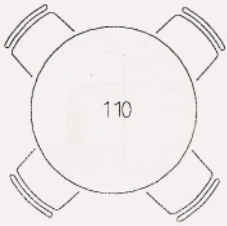

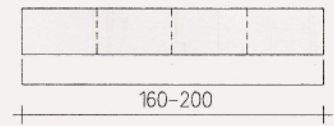
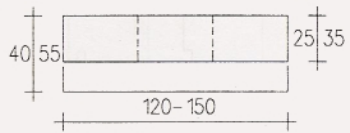
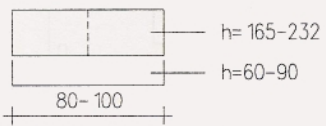
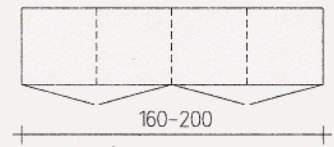
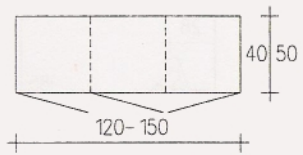
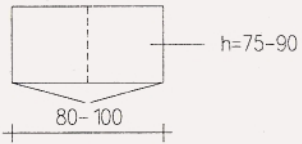

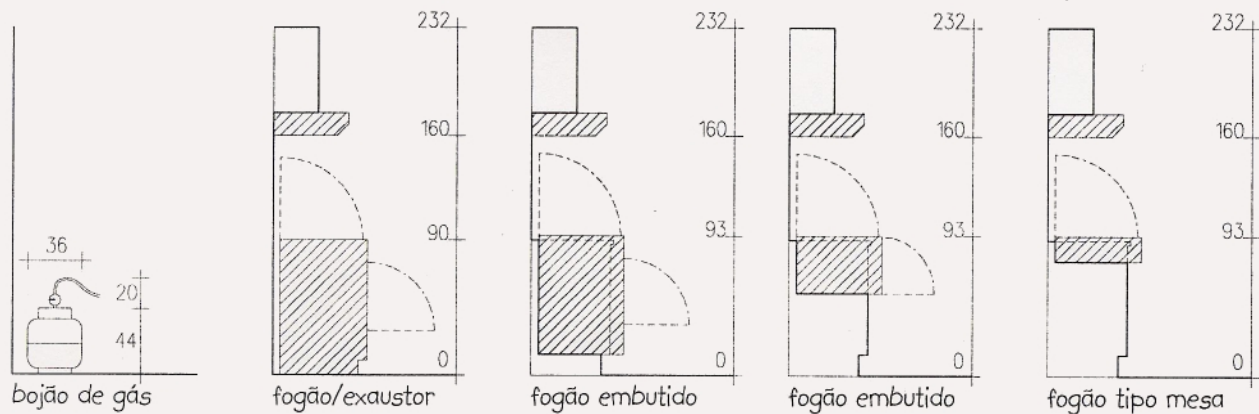
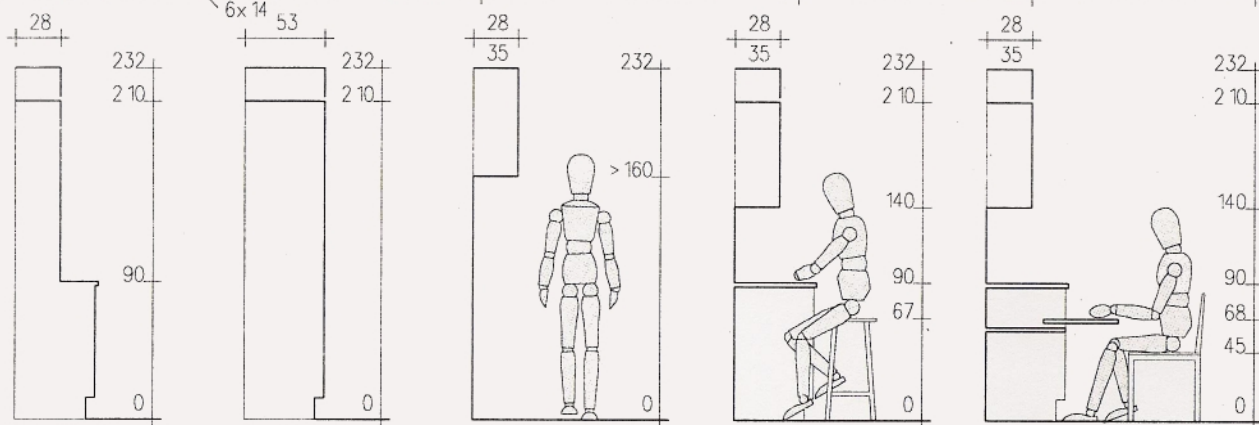
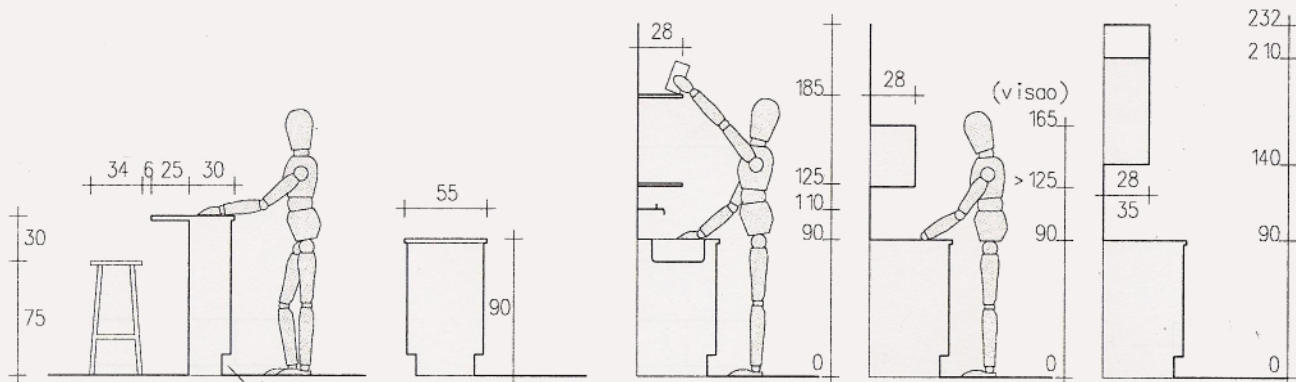



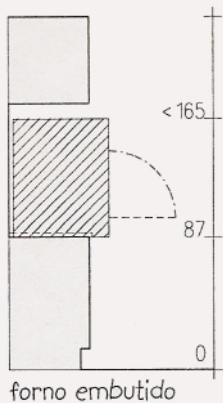

forno embutido

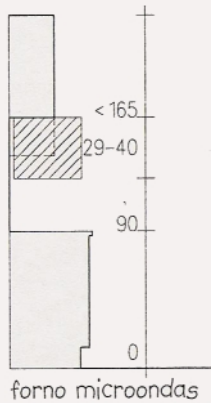

forno microondas

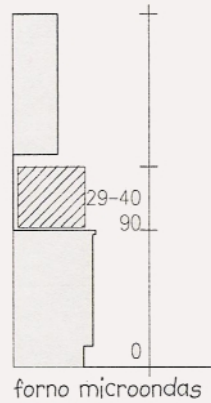

forno microondas

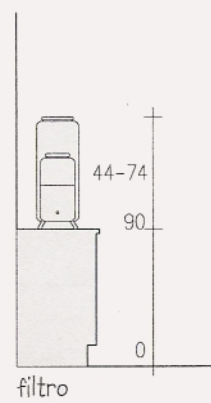

filtro

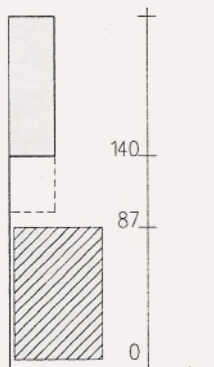

refrigerador freezer

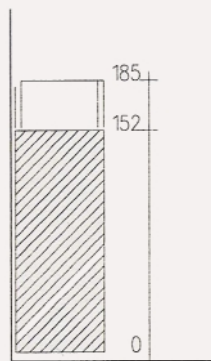

refrigerador freezer

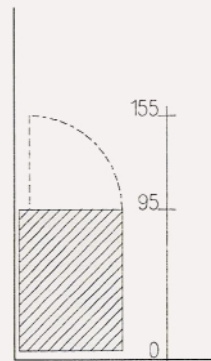

freezer horizontal

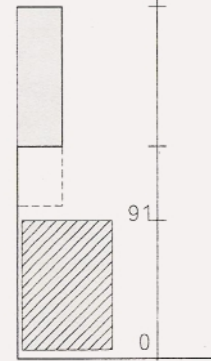

lavalouça convencional

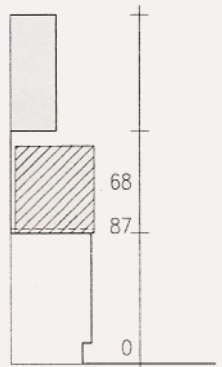

lavalouça compacta

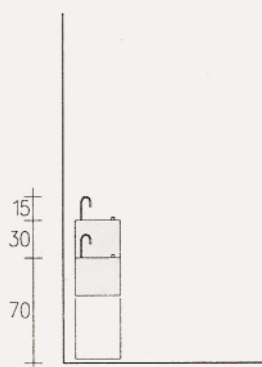

bebedouro

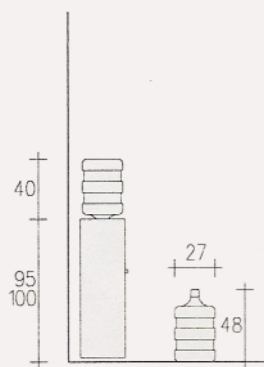

água mineral

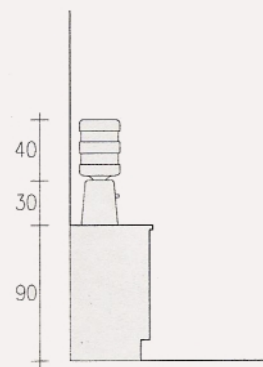

água mineral

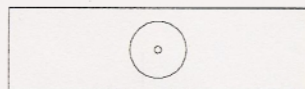
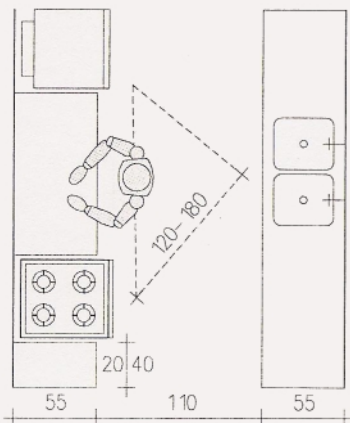
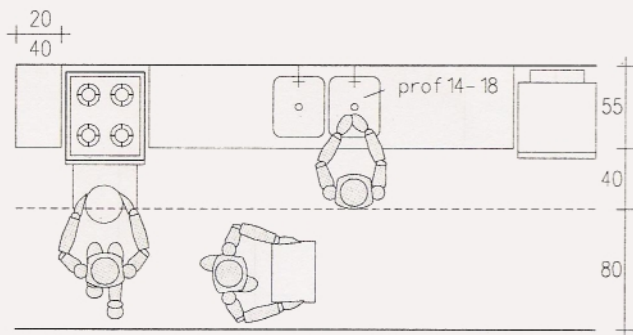

cubas d.38 p.13  
 34x40 p.15  
 30,5x47 p.14  
 33x56 p.16  
 45x50 p.20

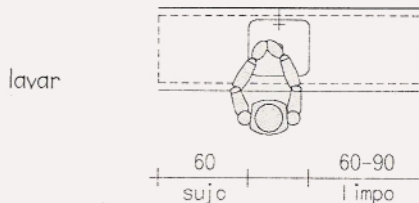
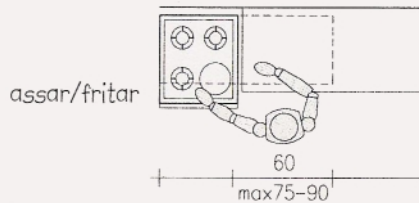
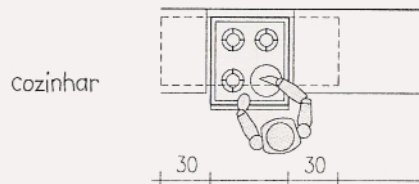
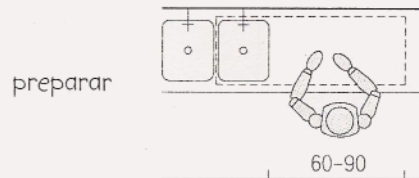
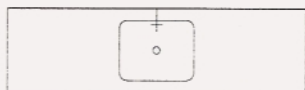

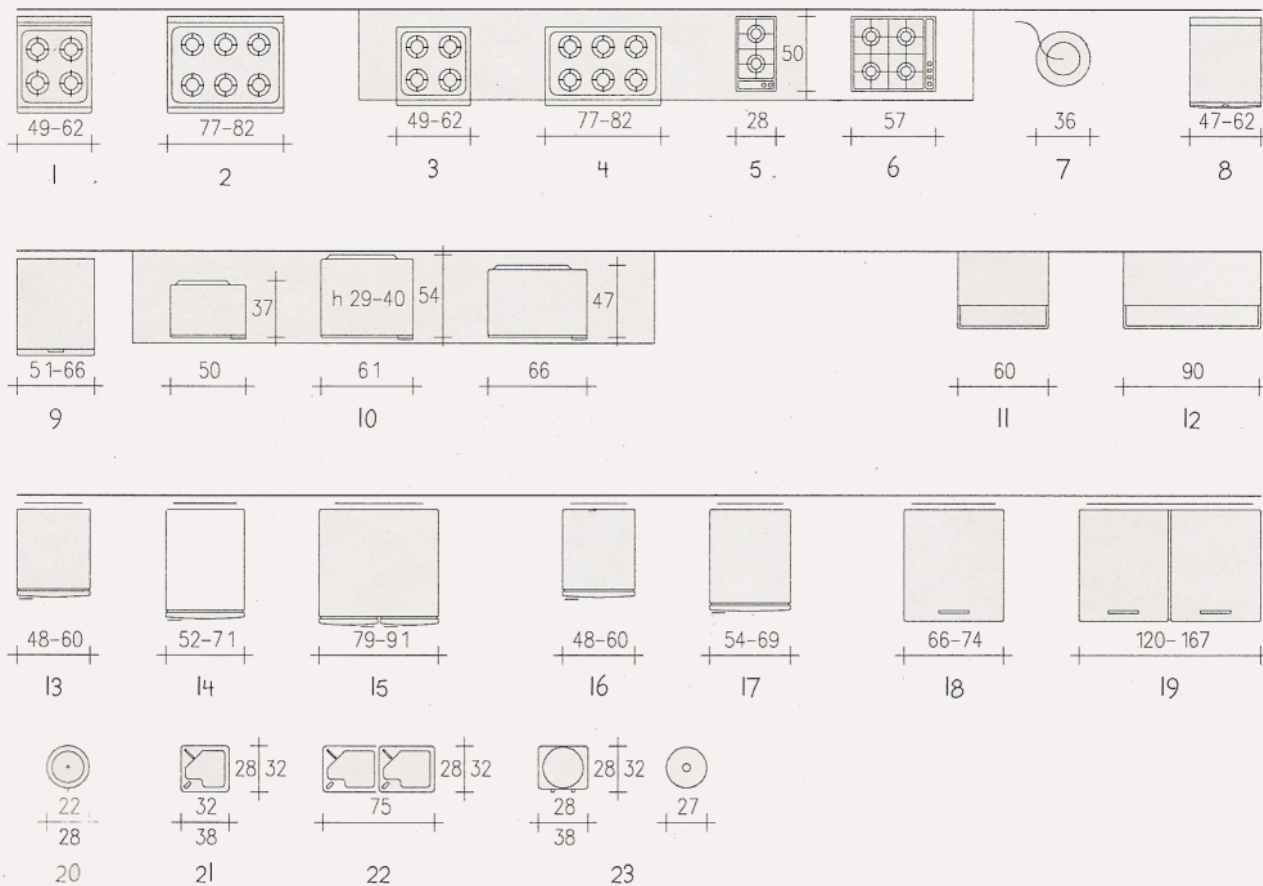

- 1 fogão 4 bocas  
 2 fogão 6 bocas  
 3 fogão tipo "mesa" com 4 bocas  
 4 fogão tipo "mesa" com 6 bocas  
 5 fogão "cooktop" com 2 bocas  
 6 fogão "cooktop" com 4 bocas  
 7 boião de gás  
 8 lavalouça

- 9 forno  
 10 fornos microondas  
 11 exaustor para 4 bocas  
 12 exaustor para 6 bocas  
 13 refrigerador (altura 87)  
 14 refrigerador  
 15 refrigerador "side by side"  
 16 freezer vertical (altura 87)

- 17 freezer vertical  
 18 freezer horizontal com 1 tampa  
 19 freezer horizontal com 2 tampas  
 20 filtros  
 21 bebedouro  
 22 bebedouro duplo  
 23 água mineral



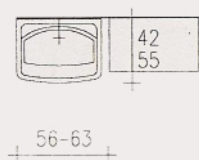

tanque de louça

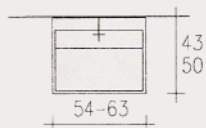

inox

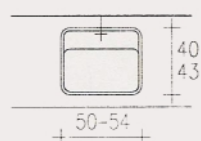

inox sobrepor

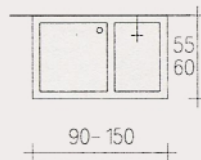

lavandaria

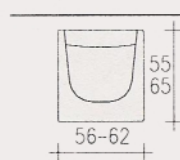

lavadora

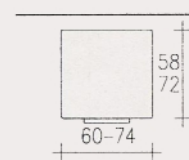

secadora

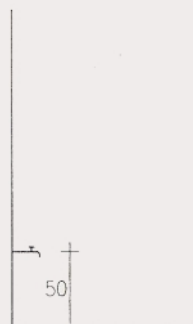

torneira

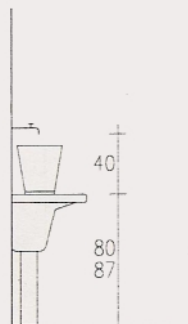

torneira alta

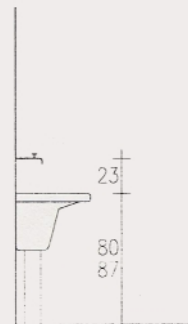

tanque de louça

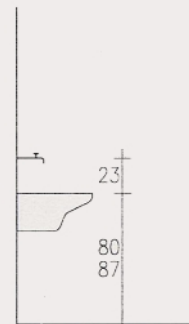

tanque de inox

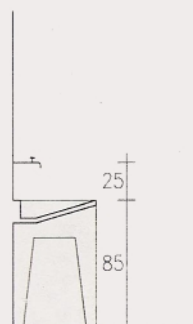

lavandaria

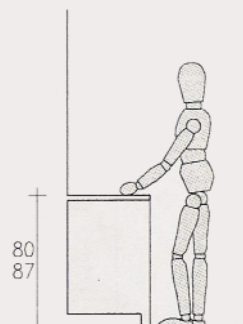

mesa de apoio

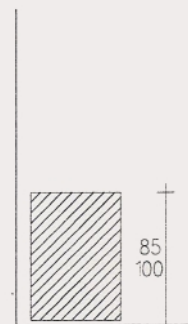

lavadora

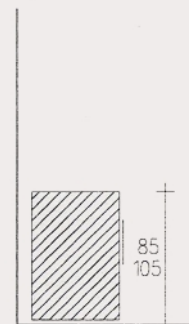

secador



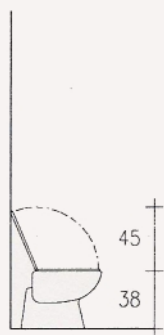
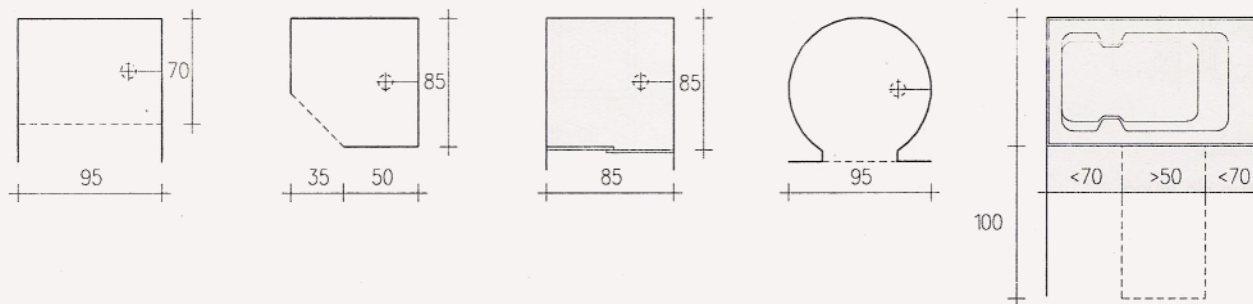

bacia

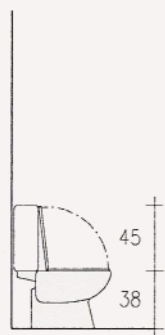

bacia c/ caixa

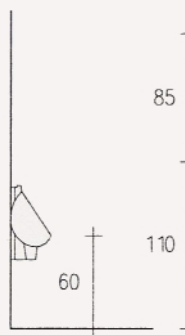

mictório

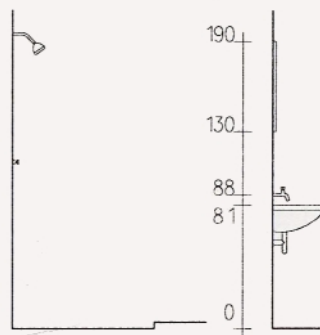

chuveiro

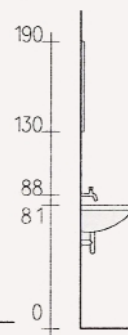

lav. c/ espelho

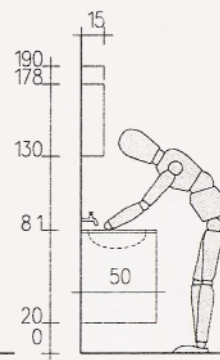

banc. c/ lav.

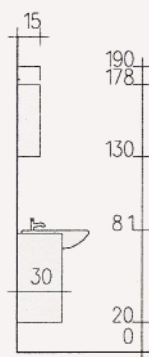

lav. semi-encaixe

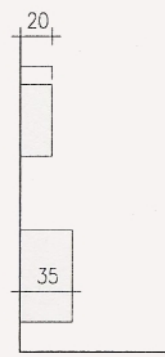

banc. s/ lav.

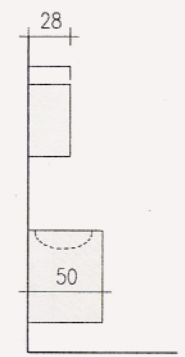

banc. c/ lav.

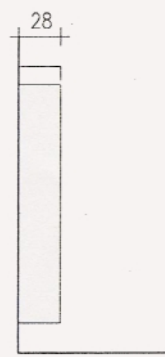

armário



armário

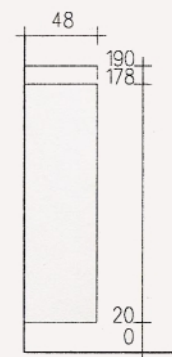

armário

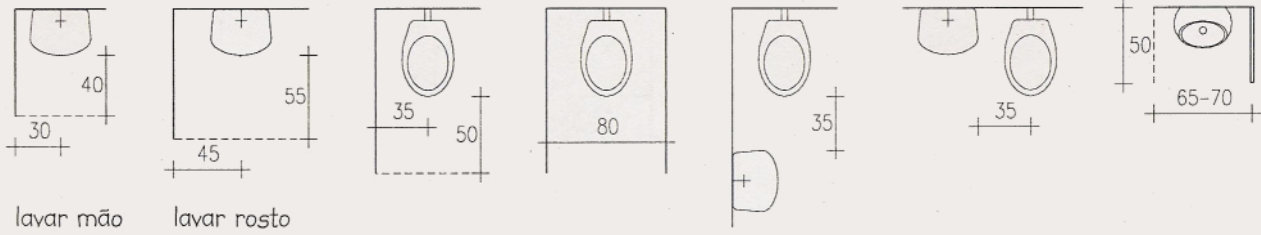

lavar mão

lavar rosto

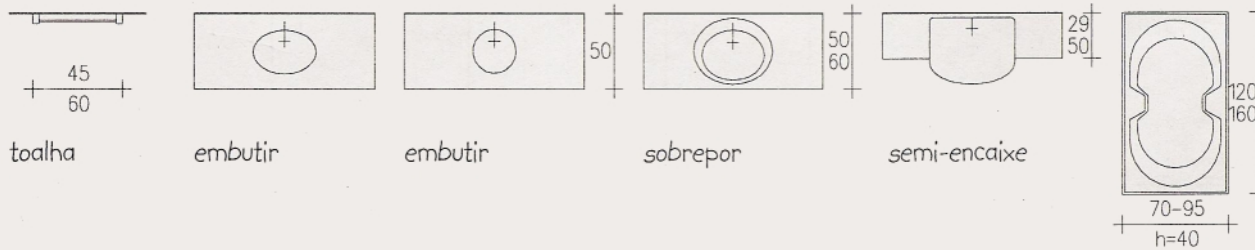
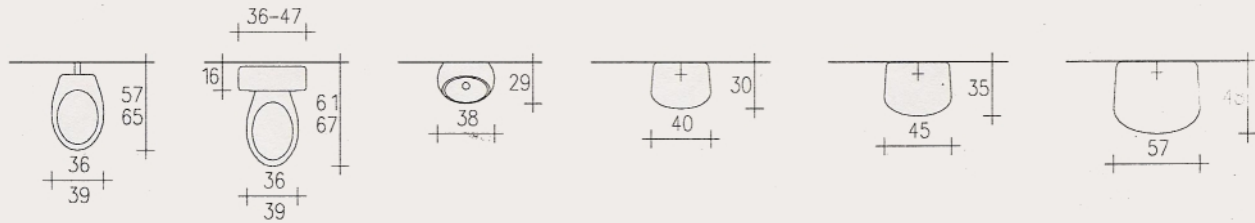

toalha

embutir

embutir

sobrepor

semi-encaixe

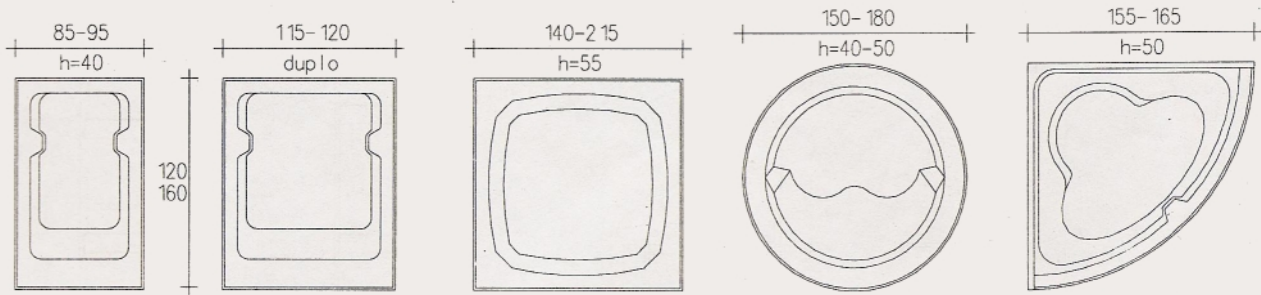

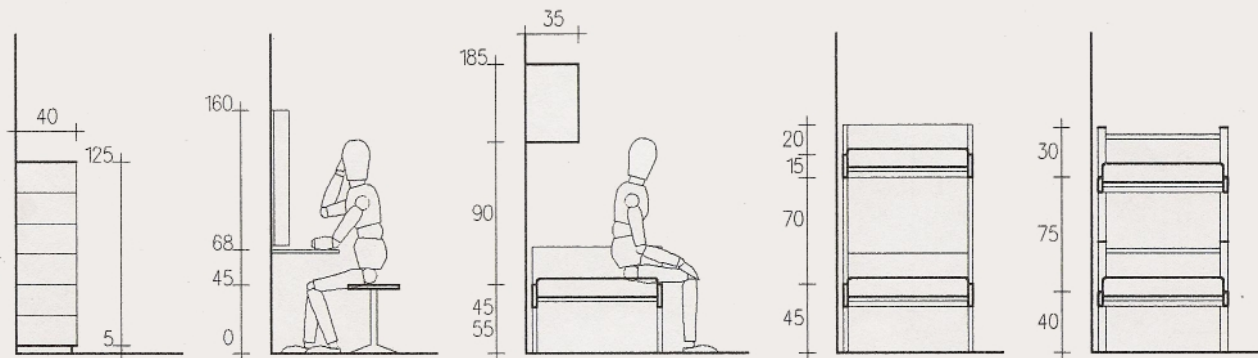
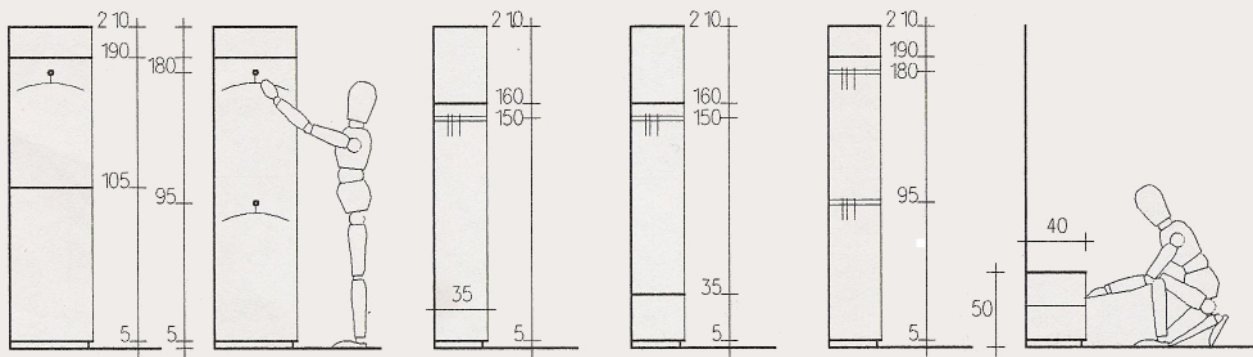
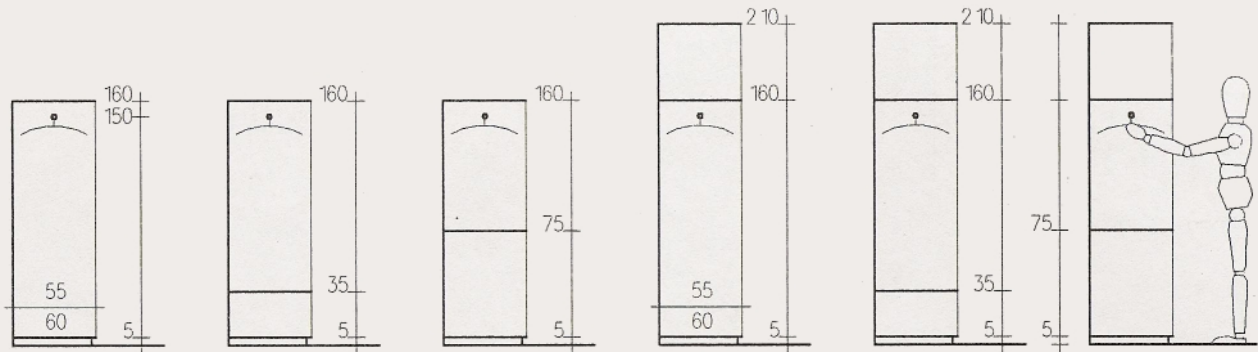

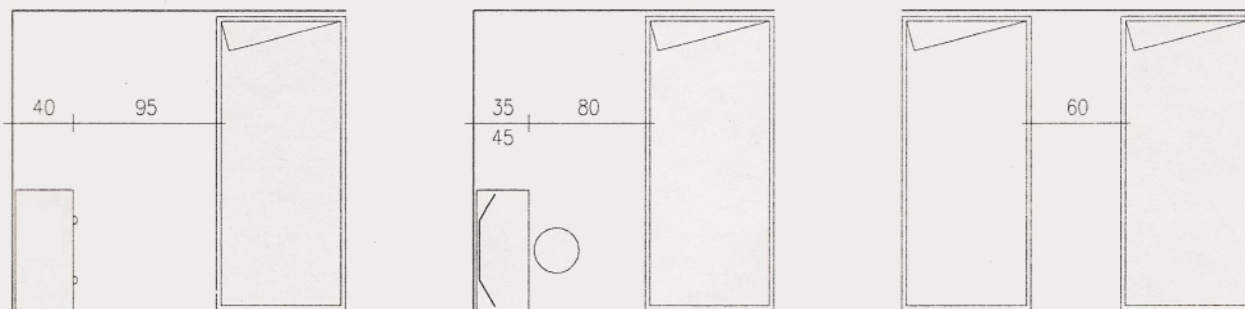
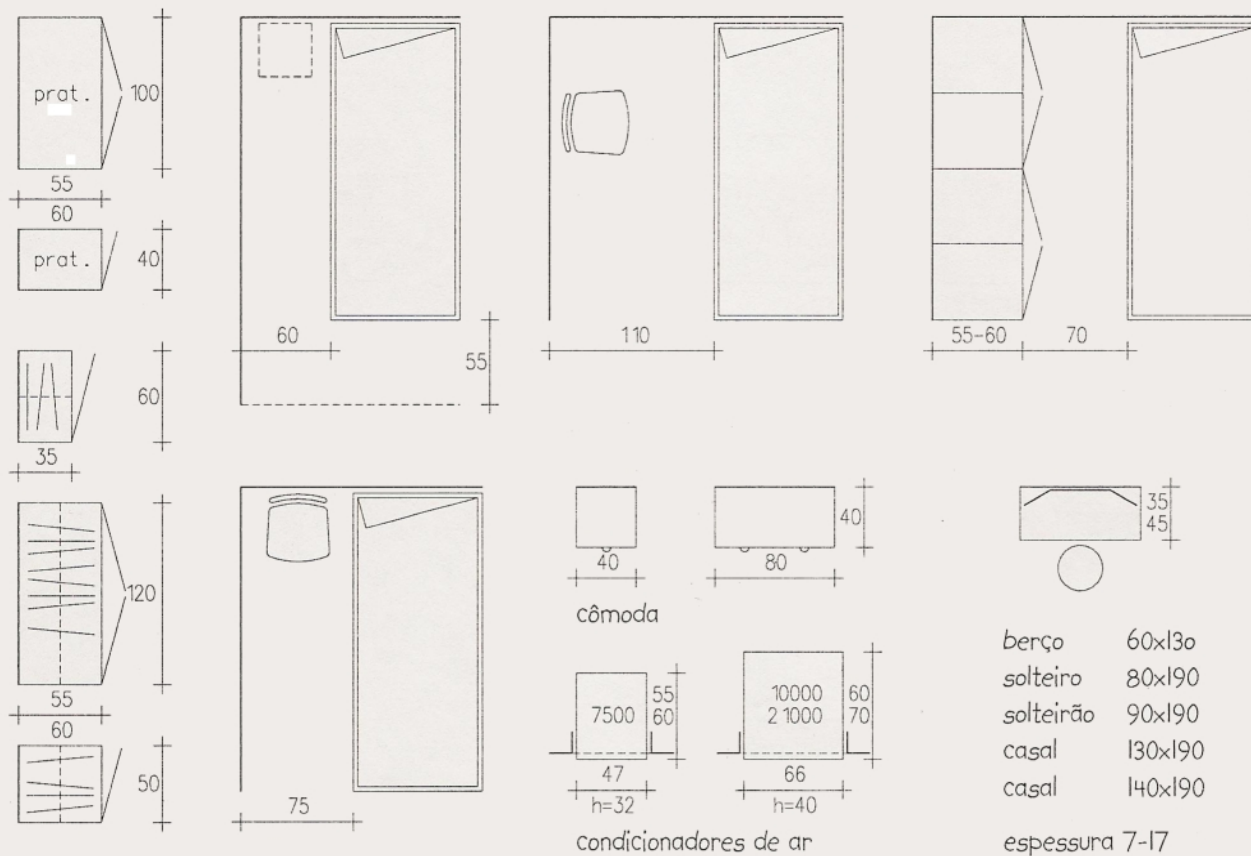



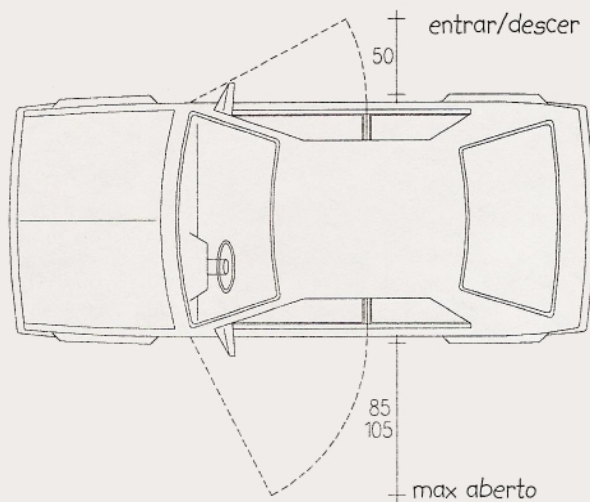
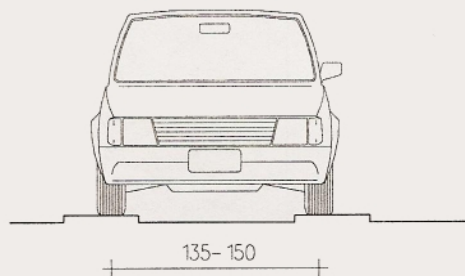
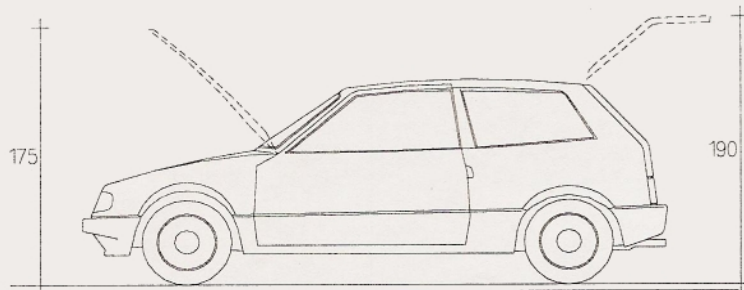

pequeno

médio

grande

ka	362 x 163	gol	388 x 163	besta	469 x 169
uno	365 x 155	corsa	403 x 161	chevr.510	479 x 169
palio	373 x 161	Kombi	450 x 172	asia/topic	525 x 169

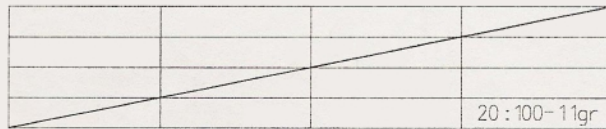
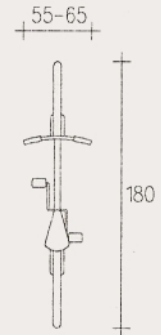
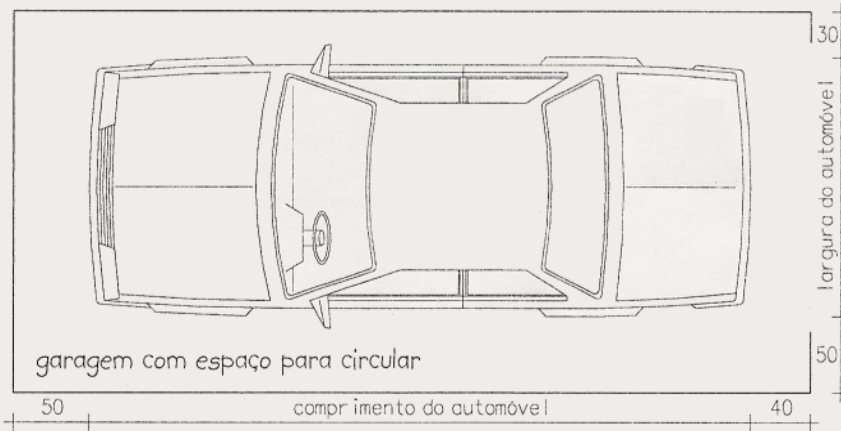
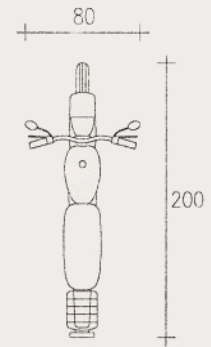
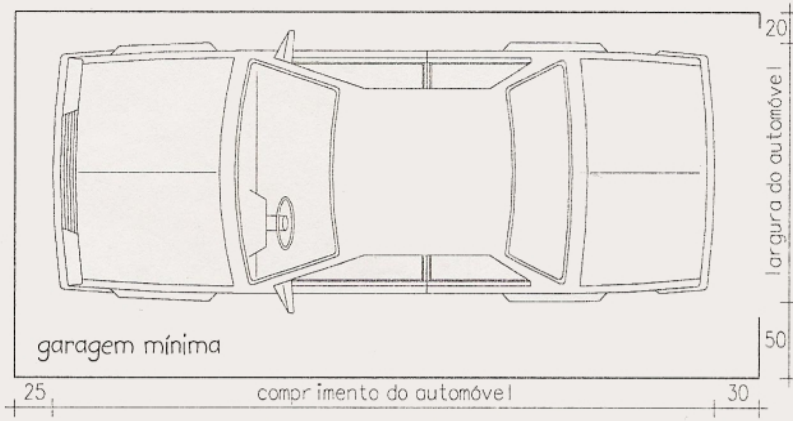

rampa max.  
para automóveis

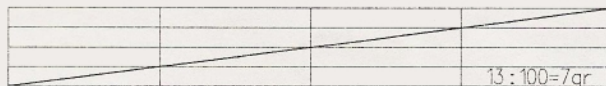

rampa normal  
para automóveis

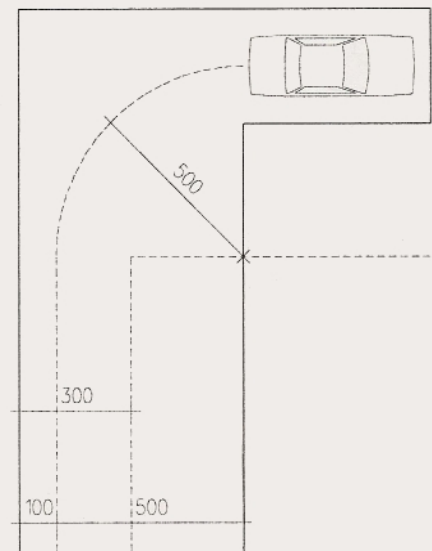
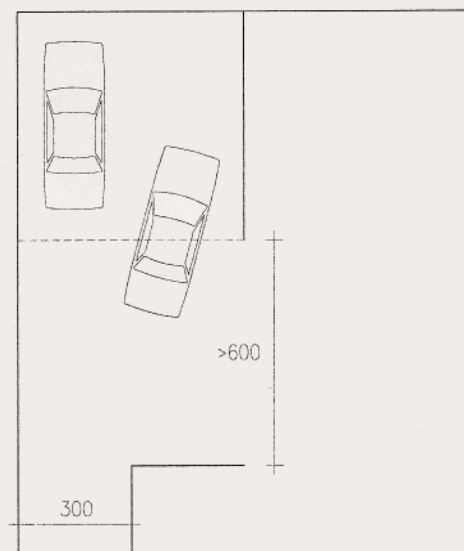
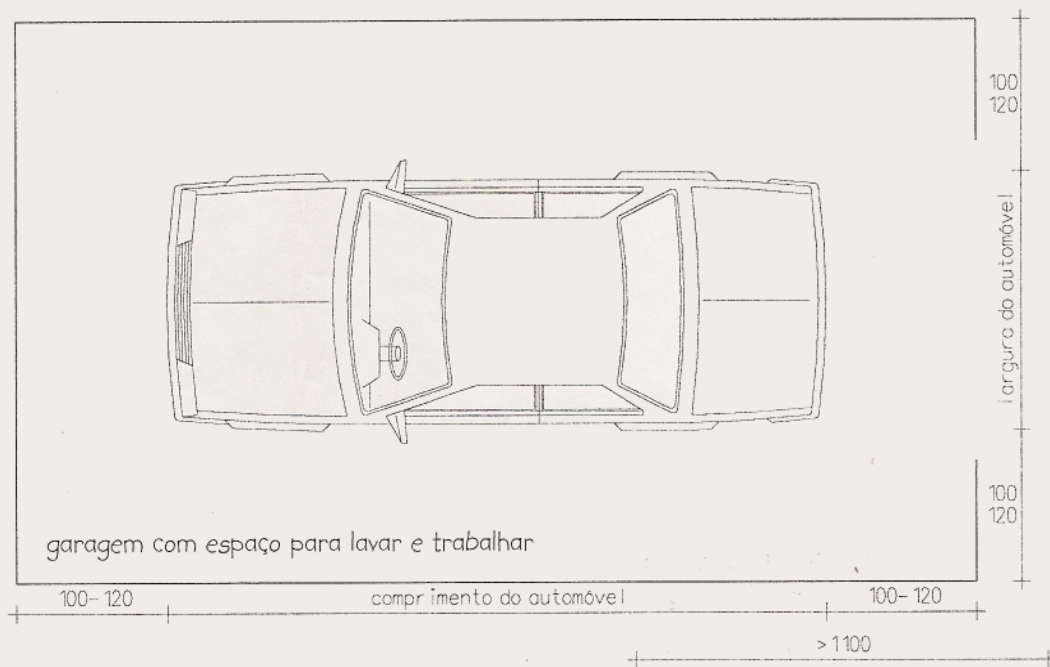

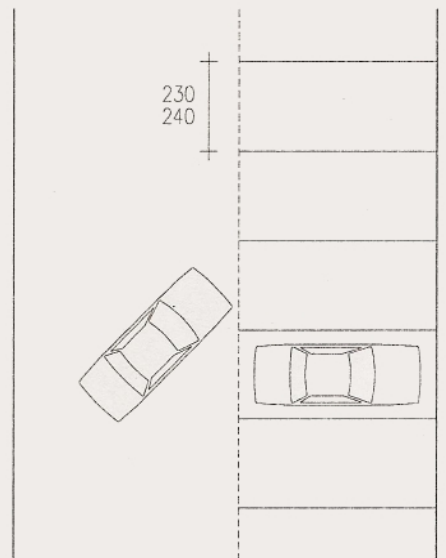
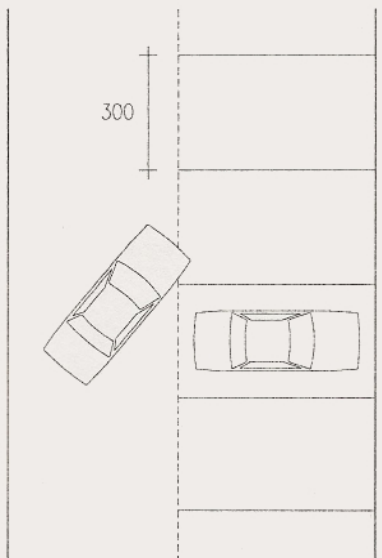
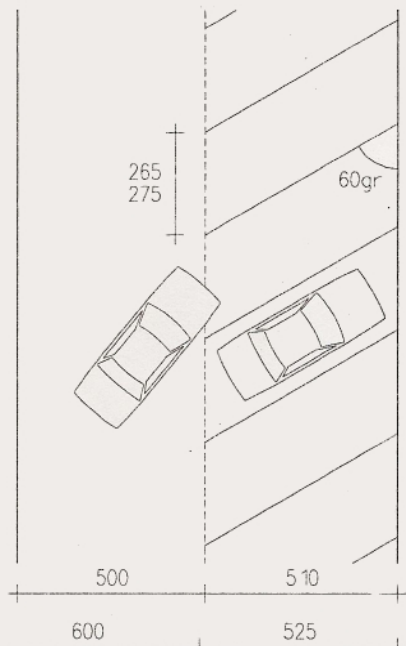
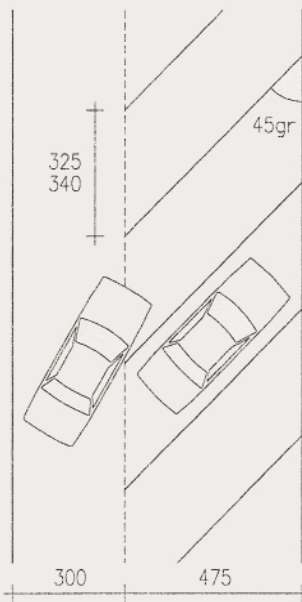
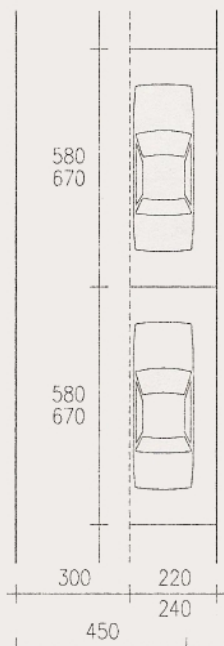

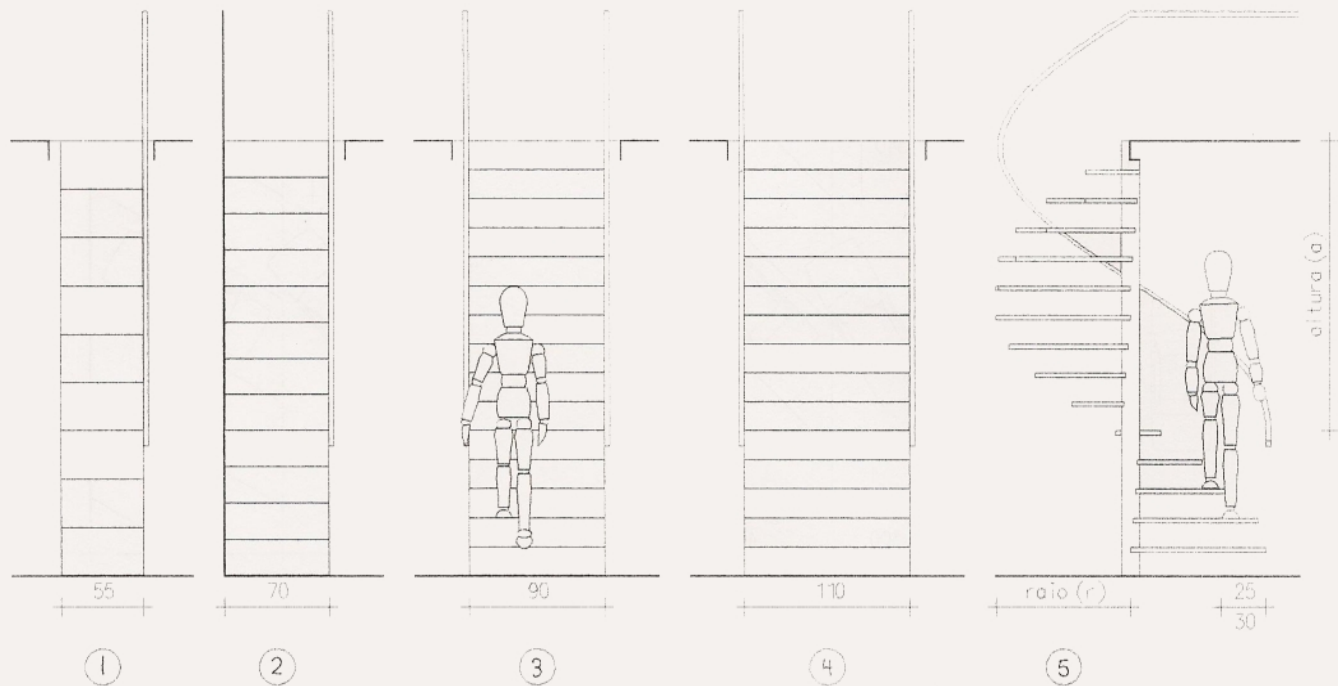

cotas medindo entre os corrimãos

- ① largura mínima p/ escadas subordinadas
- ② largura mínima p/ escadas em residências unifamiliares
- ③ largura recomendável p/ escadas em residências unifamiliares
- ④ largura mínima p/ escadas p/passagem de 2 pessoas quando houver mais de 2 pavimentos
- ⑤ raio mínimo 70cm, p/ escadas helicoidais (para "r" e "a" ver tabelas nas páginas 30-35)

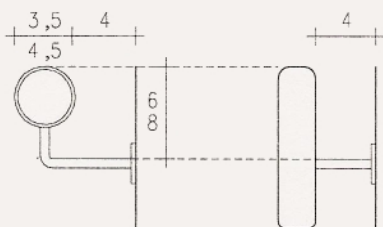

quando o lance da escada tiver mais de 5 degraus é recomendável colocar um corrimão.

comprimento do lance da escada max 18 degraus.

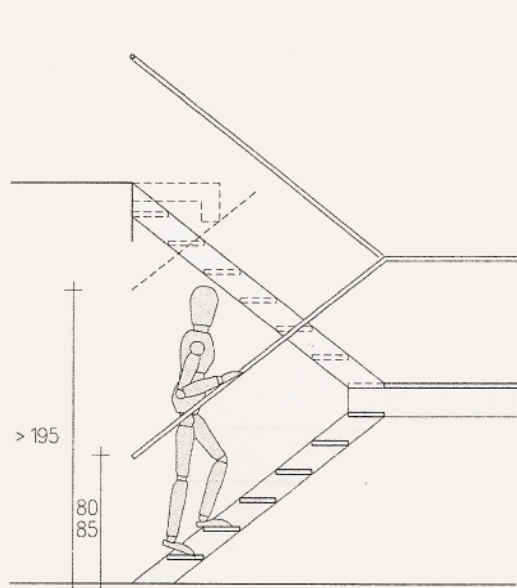
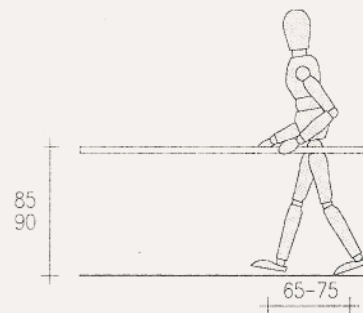
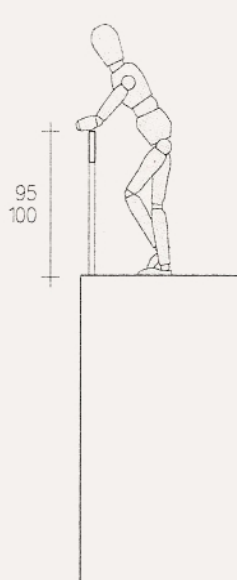

escadas residenciais 25-45gr



escadas de serviço 50-75gr.

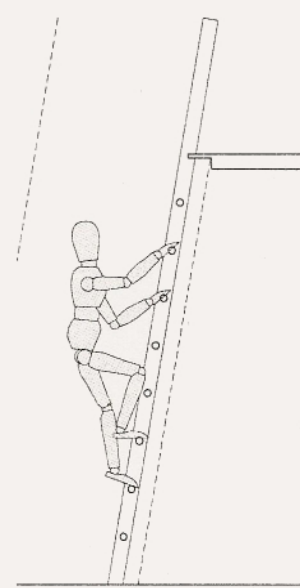

escadas de mão 75-90gr.





rampa max. para pedestres 14:100=8gr.  
rampa normal para pedestres 10:100=6gr.

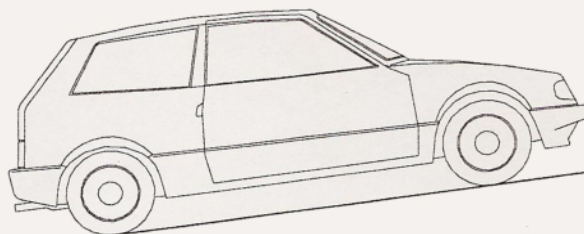

rampa max. para automóveis 20:100=11gr.  
rampa normal para automóveis 13:100=7gr.

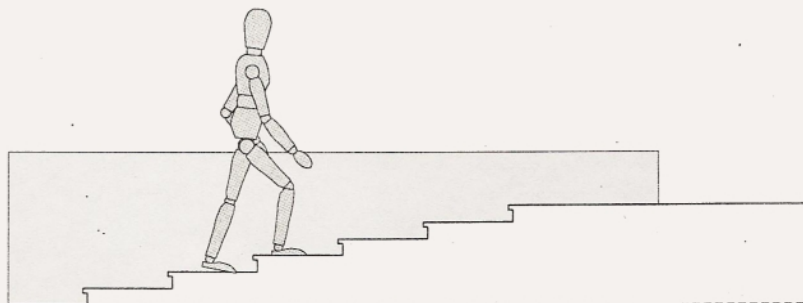

escadarias 7-20gr.

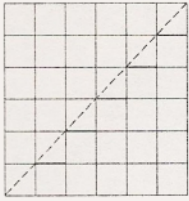

21x20=46gr.

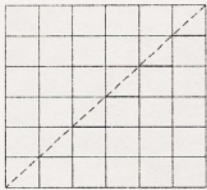

20x22=42gr.

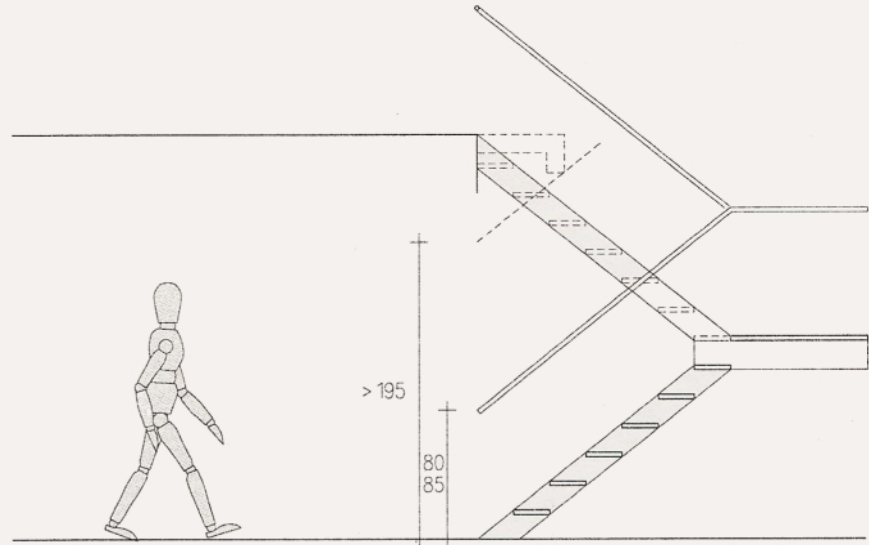

escadas residenciais 25-45gr

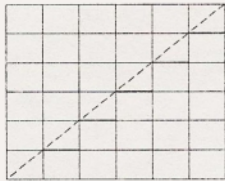

19x24=38gr.

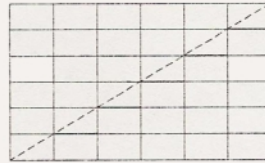

17x29=30gr.

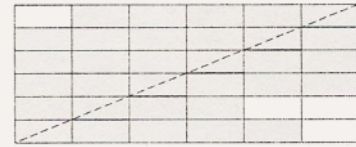

15x38=22gr.

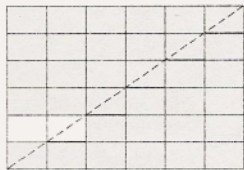

18x26=35gr.

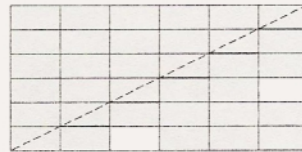

16x33=26gr.

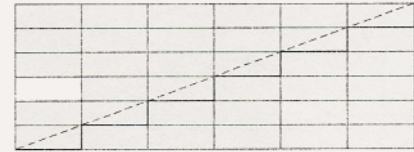

16x44=20gr.

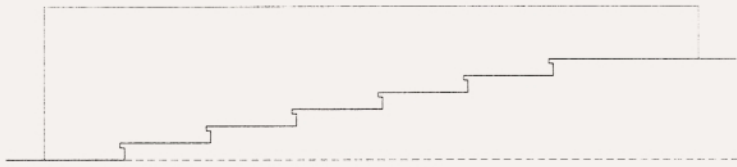

escadarias 7-20gr.

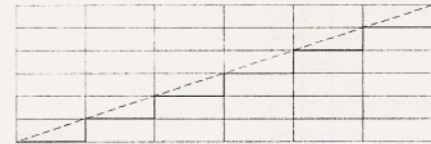

$$15 \times 46 = 18 \text{gr.}$$

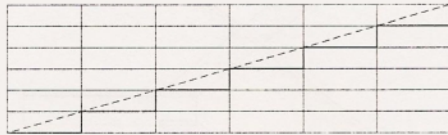

$$14 \times 49 = 16 \text{gr.}$$

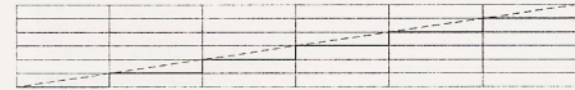

$$9 \times 62 = 8 \text{gr.}$$

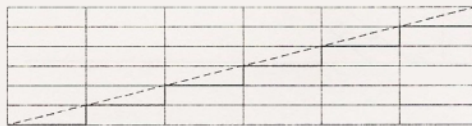

$$13 \times 52 = 14 \text{gr.}$$

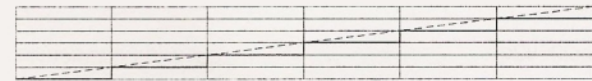

$$8 \times 64 = 7 \text{gr.}$$

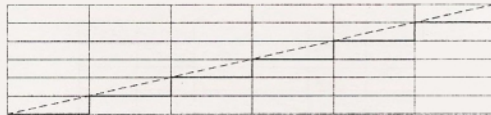

$$12 \times 54 = 13 \text{gr.}$$

espelho	piso	inclinação
16	196	5
15	198	4
14	201	4
13	204	4
12	206	3
11	209	3
10	211	3
9	214	2
8	216	2

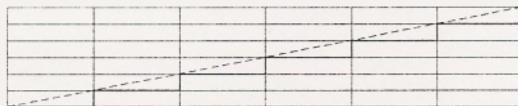

$$11 \times 57 = 11 \text{gr.}$$

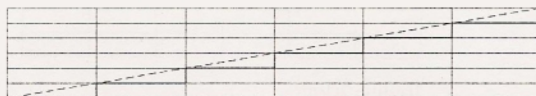

$$10 \times 59 = 10 \text{gr.}$$

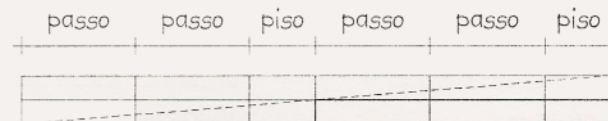

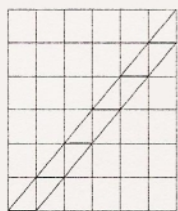

degr. 22  
incl. 50gr.  
corrimão 88  
livre 162

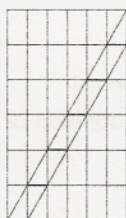

degr. 23  
incl. 60gr.  
corrimão 90  
livre 145

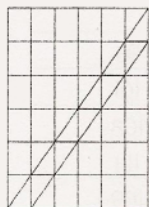

degr. 22  
incl. 55gr.  
corrimão 88  
livre 157

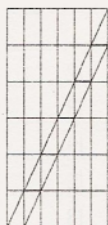

degr. 24  
incl. 65gr.  
corrimão 91  
livre 132



escadas de serviço 50-75gr.

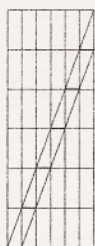

degr. 26  
incl. 70gr.  
corrimão 92  
livre 127

degrau cm	inclinação	livre cm
27-33	75gr	115
28-34	80gr	100
29-36	85gr	90
30-38	90gr	80

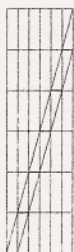

degr. 27  
incl. 75gr.  
corrimão 95  
livre 115

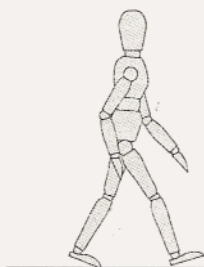

escadas de mão 75-90gr.

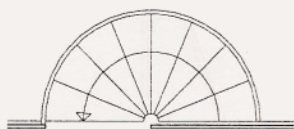

degrau normal

r. = raio (até lado de dentro do corrimão)

espelho cm	piso cm	inclinação	nr de degr.	pé dir. cm	r. cm
21	20	46gr	12	252	95
			13	273	101
			14	294	108
			15	315	114
20	22	42gr	13	260	109
			14	280	116
			15	300	123
			16	320	130
19	24	38gr	13	247	117
			14	266	124
			15	285	132
			16	304	140
18	26	35gr	14	252	133
			15	270	141
			16	288	149
			17	306	157
17	29	30gr	15	255	154
			16	272	163
			17	289	173
			18	306	182
16	33	26gr	16	256	183
			17	272	193
			18	288	204
			19	304	214

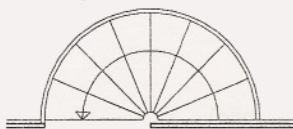

degrau mínimo (fórmula  $2e+lp=60\text{cm.}$ )  
 r. = raio (até lado de dentro do corrimão)

espelho cm	piso cm	inclinação	nr de degr.	pé dir. cm	r. cm
21	18	49gr	12	252	88
			13	273	94
			14	294	99
			15	315	105
20	20	45gr	13	260	101
			14	280	108
			15	300	114
			16	320	120
19	22	41gr	13	247	109
			14	266	116
			15	285	123
			16	304	130
18	24	37gr	14	252	124
			15	270	132
			16	288	140
			17	306	147
17	26	33gr	15	255	141
			16	272	149
			17	289	157
			18	306	166
16	28	30gr	16	256	159
			17	272	168
			18	288	177
			19	304	185



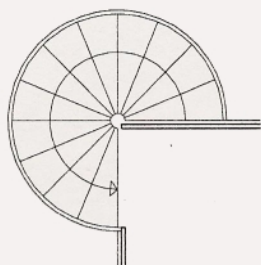

degrau normal

r. = raio (até lado de dentro do corrimão)

espelho cm	piso cm	inclinação	nr de degr.	pé dir. cm	r. cm
21	20	46gr	12	252	72
			13	273	76
			14	294	80
			15	315	84
20	22	42gr	13	260	81
			14	280	86
			15	300	90
			16	320	95
19	24	38gr	13	247	86
			14	266	91
			15	285	96
			16	304	101
18	26	35gr	14	252	97
			15	270	102
			16	288	108
			17	306	113
17	29	30gr	15	255	111
			16	272	117
			17	289	123
			18	306	130
16	33	26gr	16	256	130
			17	272	137
			18	288	144
			19	304	151

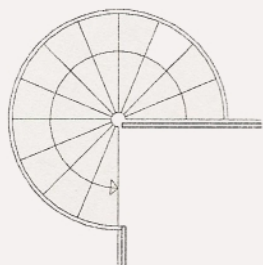

degrau mínimo (fórmula  $2e+1p=60\text{cm.}$ )  
 r. = raio (até lado de dentro do corrimão)

espelho cm	piso cm	inclinação	nr de degr.	pé dir. cm	r. cm
21	18	49gr	13	273	71
			14	294	75
			15	315	78
20	20	45gr	13	260	76
			14	280	80
			15	300	84
19	22	41gr	16	320	89
			13	247	81
			14	266	86
18	24	37gr	15	285	90
			16	304	95
			14	252	91
17	26	33gr	15	270	96
			16	288	101
			17	306	106
			15	255	102
16	28	30gr	16	272	108
			17	289	113
			18	306	119
			16	256	114
16	28	30gr	17	272	120
			18	288	126
			19	304	132

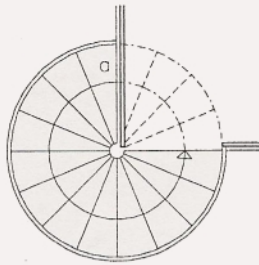

degrau normal

r. = raio (até lado de dentro do corrimão)

a. = altura até o piso do pavimento sup.

espelho cm	piso cm	inclinação	nr de degr.	pé dir. cm	r. cm	a. cm
21	20	46gr	15	315	70	221
20	22	42gr	15	300	74	210
			16	320	78	225
19	24	38gr	15	285	78	199
			16	304	82	214
18	26	35gr	16	288	87	202
			17	306	91	216
17	29	30gr	17	289	99	204
			18	306	103	217
16	33	26gr	18	288	114	204
			19	304	120	216

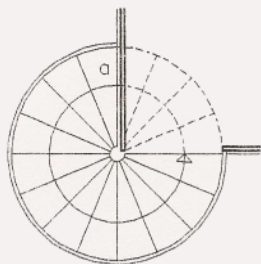

degrau mínimo (fórmula  $2e+lp=60\text{cm.}$ )

r. = raio (até lado de dentro do corrimão)

a. = altura até o piso do pavimento sup.

espelho cm	piso cm	inclinação	nr de degr.	pé dir. cm	r. cm	a. cm
20	20	45gr	15	300	70	210
			16	320	73	225
19	22	41gr	15	285	74	200
			16	304	78	214
18	24	37gr	16	288	82	203
			17	306	86	216
17	26	33gr	17	289	91	204
			18	306	95	217
16	28	30gr	18	288	101	204
			19	304	105	216



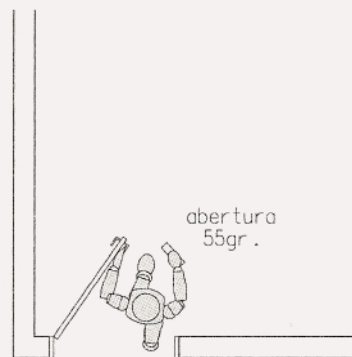
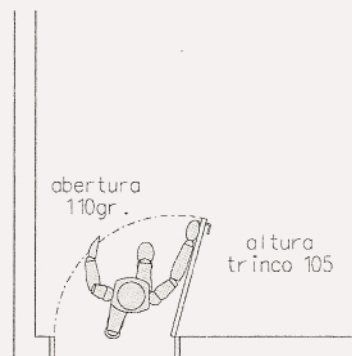
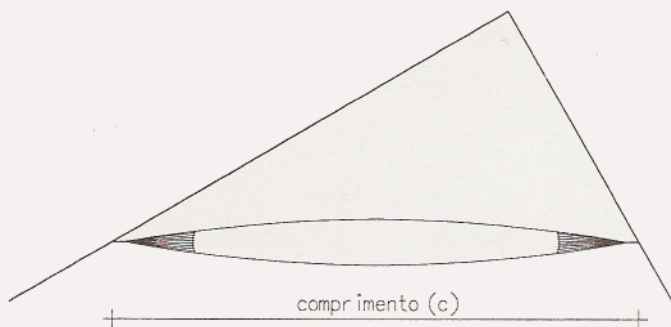
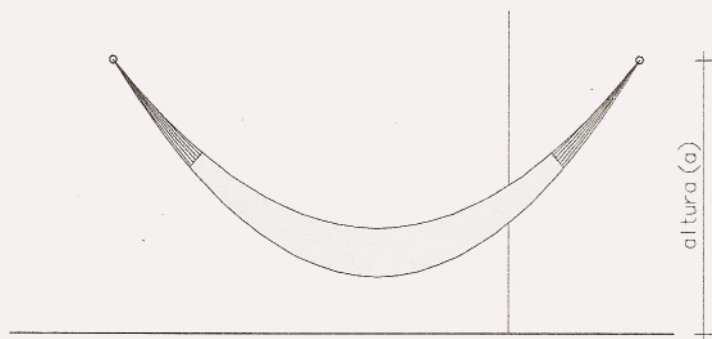

	c	a
rede peq. 370	270	190
	310	170
	350	135
rede med. 410	300	200
	340	180
	380	150
rede gr. 450	330	215
	370	195
	410	165

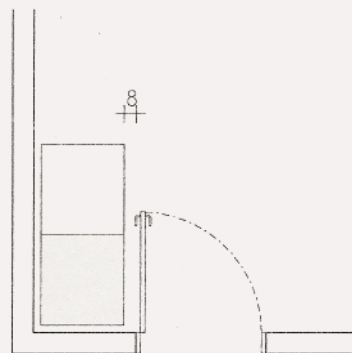
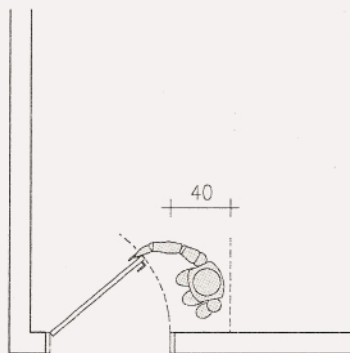





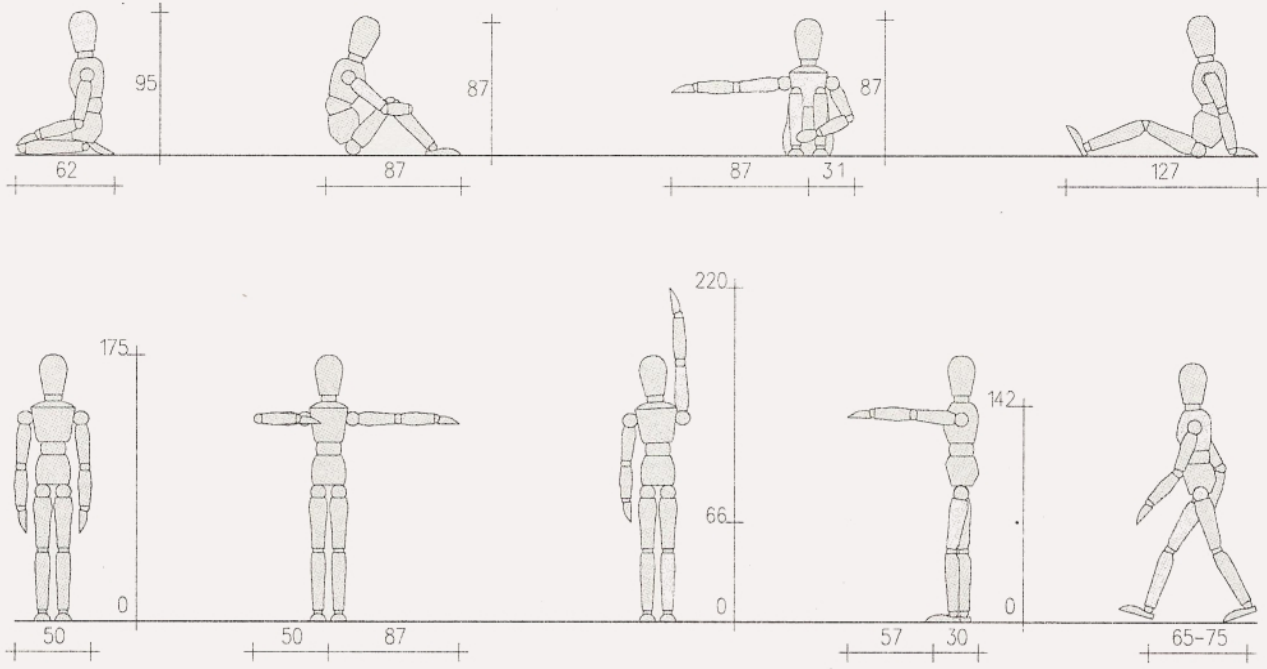

NBR 9050

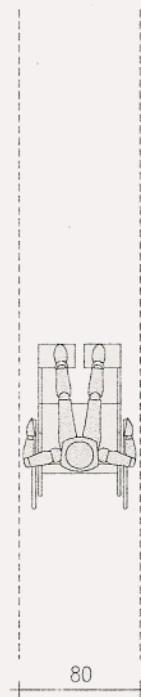
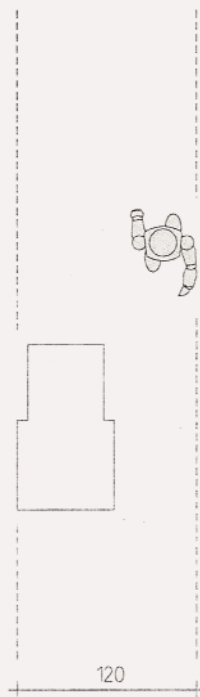
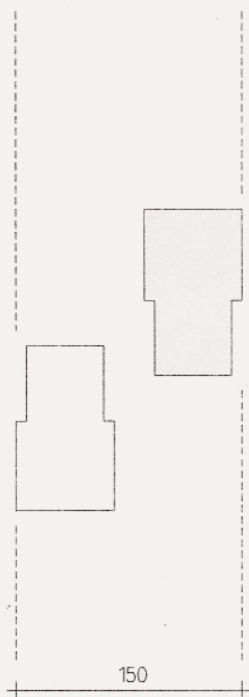
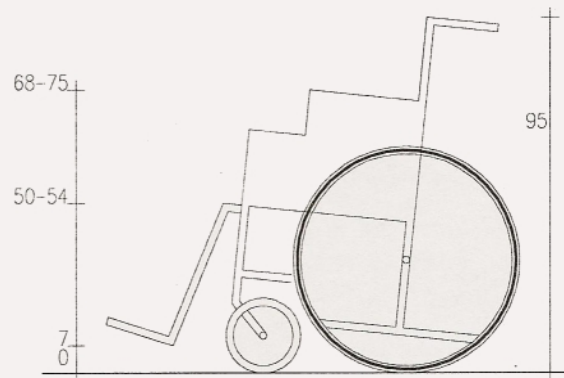
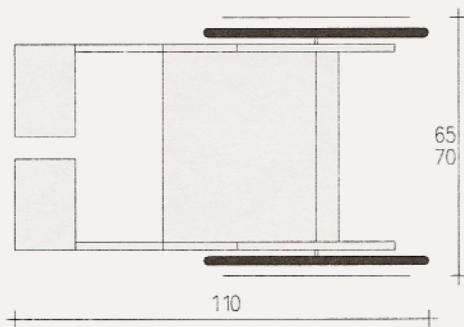

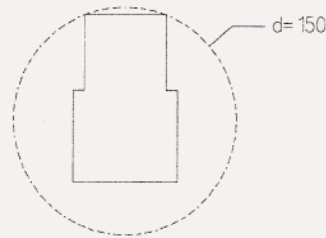
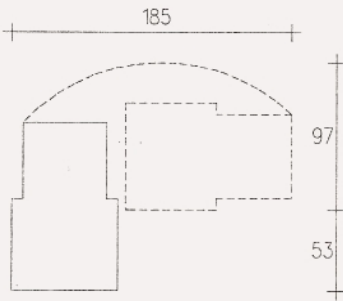
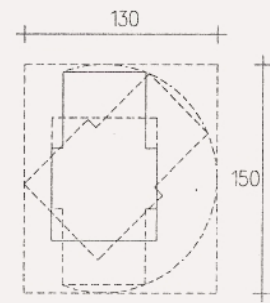
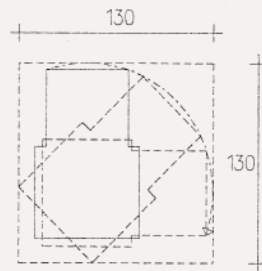
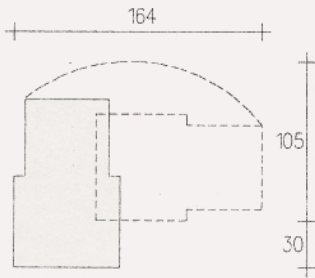

cada ambiente deve  
ter espaço p/ giro de  
360gr

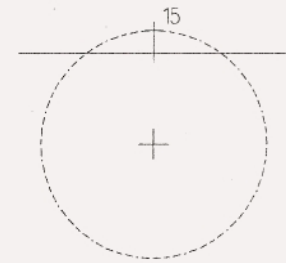

mesa  
bancada  
balcão de cozinha  
cama  
armário

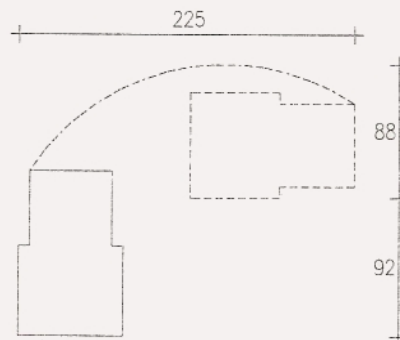
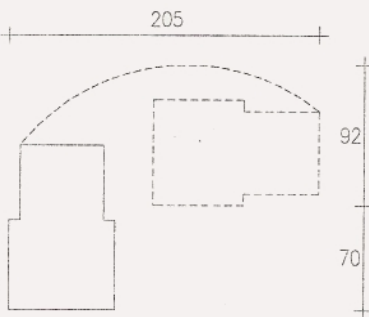

NBR 9050

NBR 9050

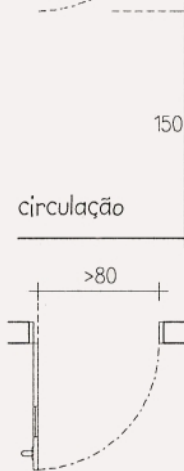
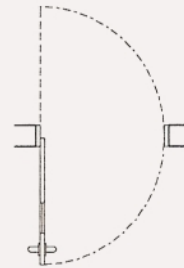
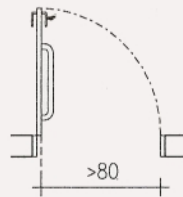
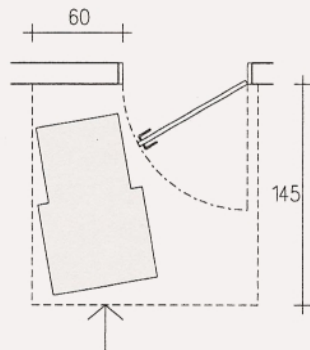
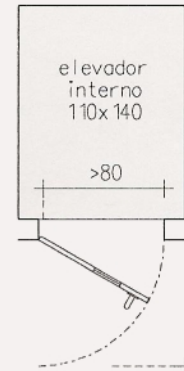
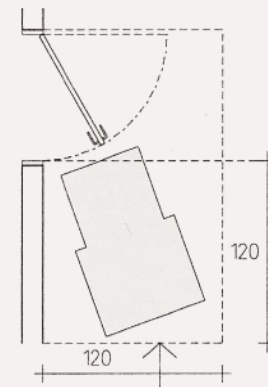
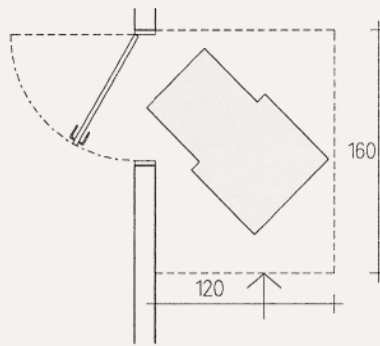
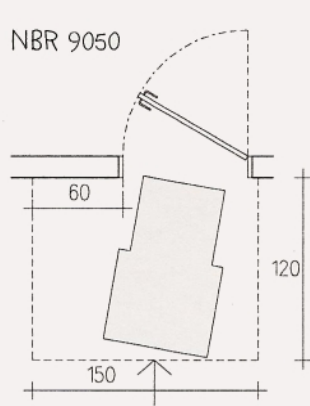

circulação

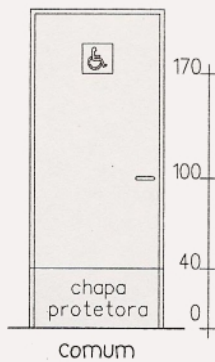

comum

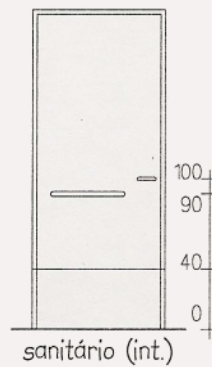

sanitário (int.)

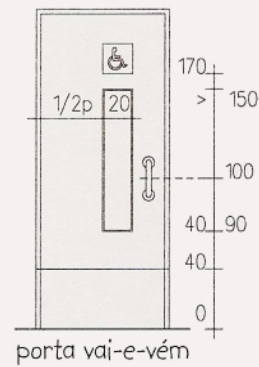

porta vai-e-vém

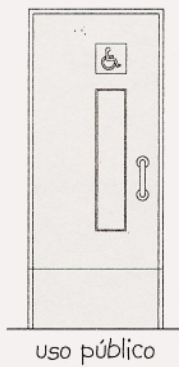

uso público

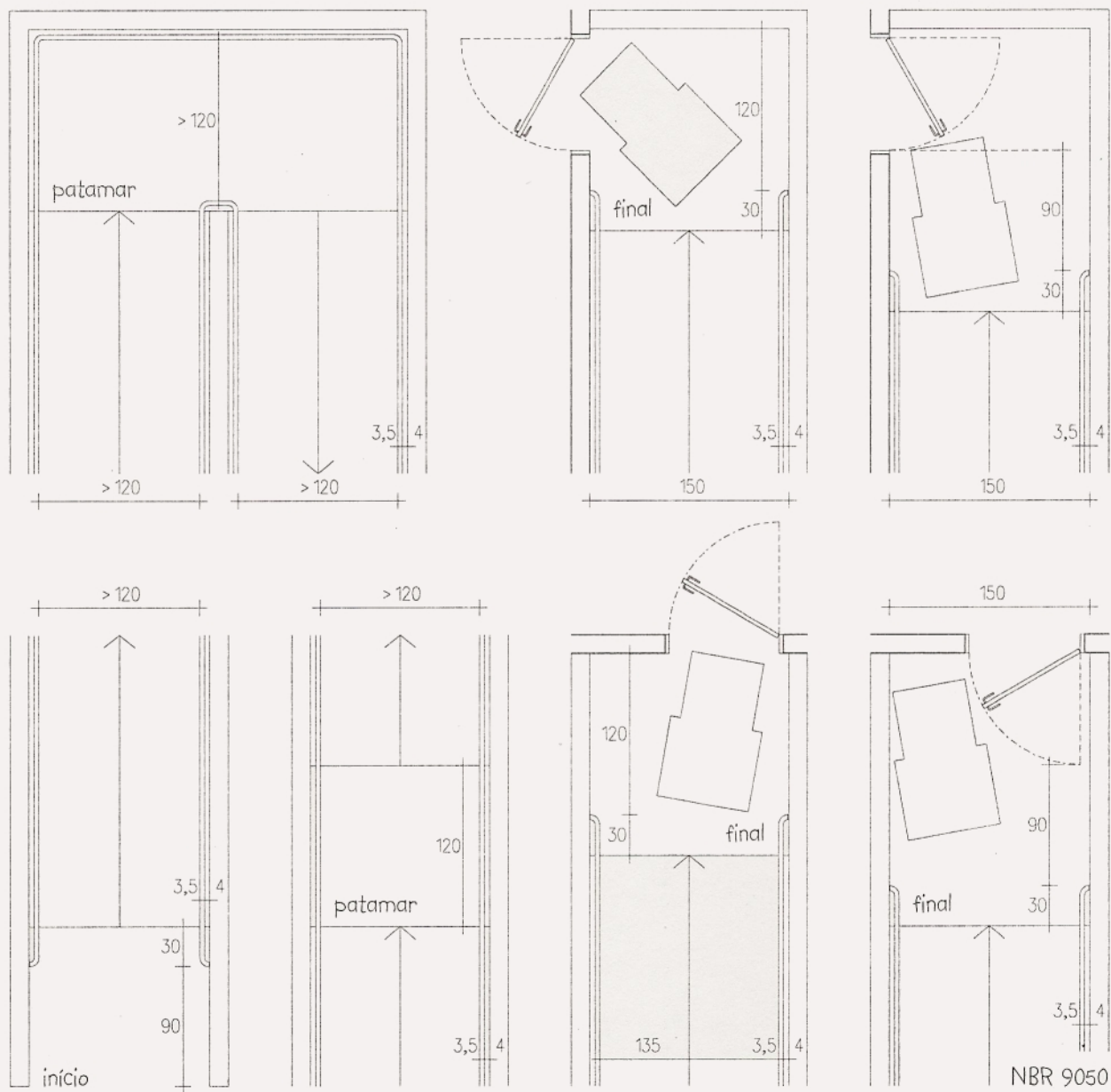



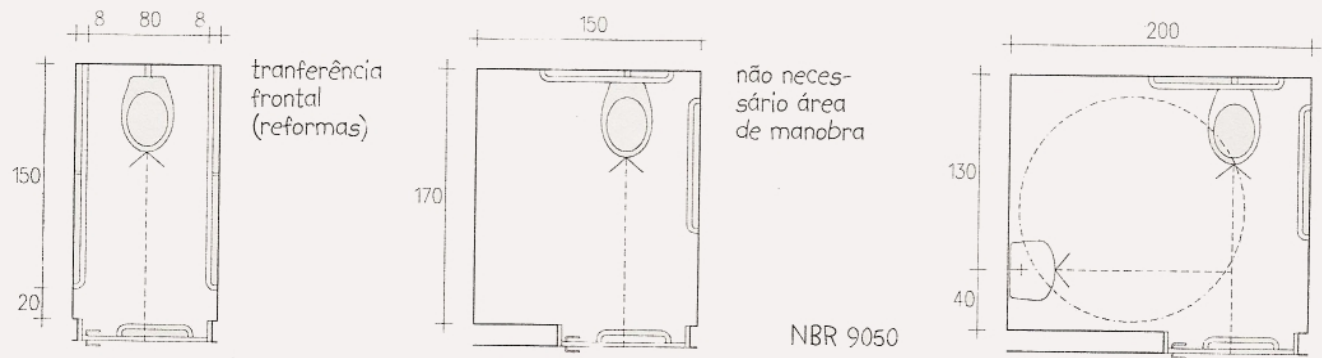
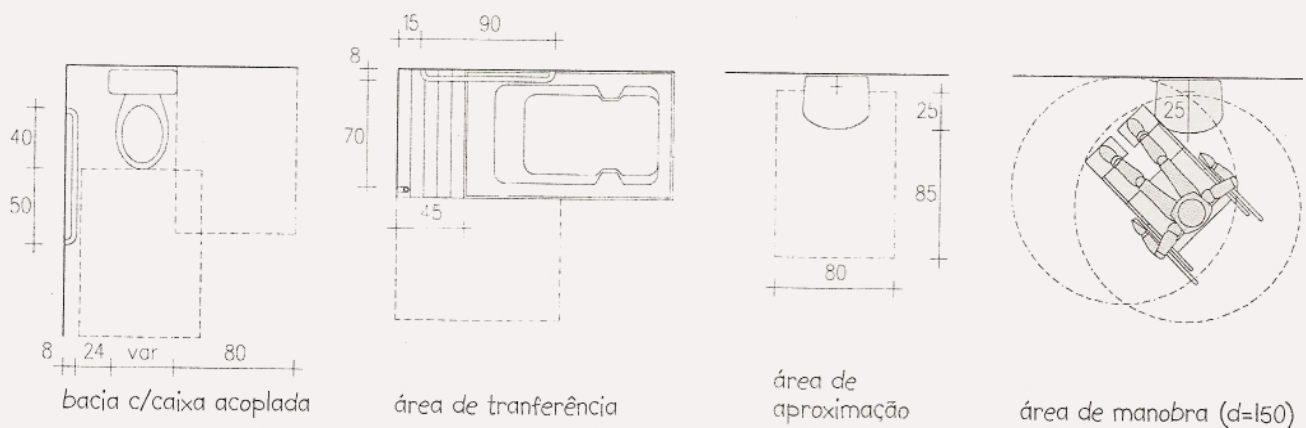

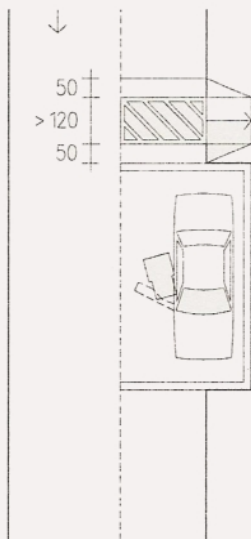
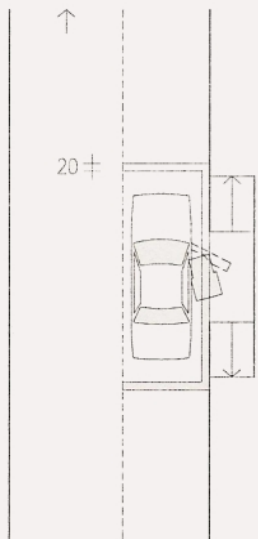
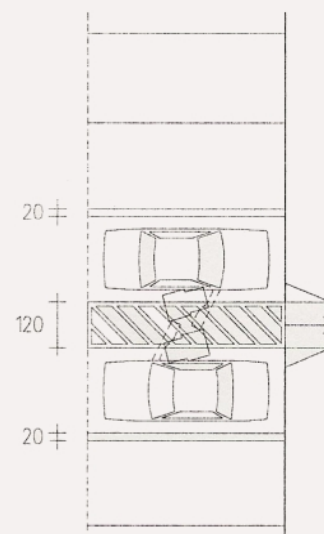
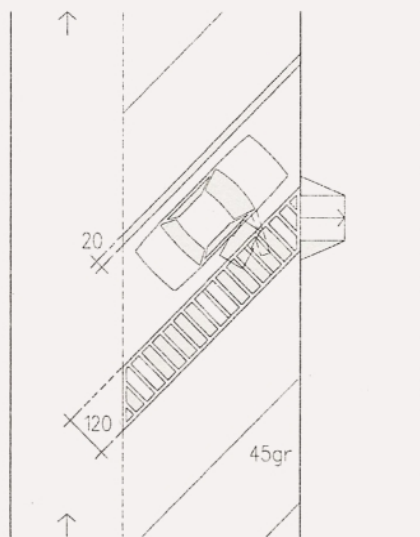
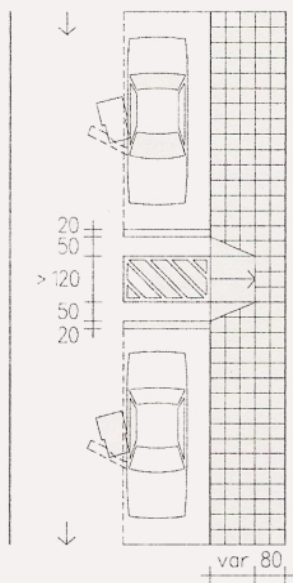

declividade máxima  
das rampas 1:8 (12,5%)  
para sinalização ver NBR 9050

passageo rebaixado

baia avançada no passageo

NBR 9050



rampa para cadeira de rodas 1 : 10

(a) max 8 seg. de 27,4cm, 6 seg. de 50cm ou 4 seg. de 75cm



rampa para cadeira de rodas 1 : 12

(a) max 10 seg. de 90cm



rampa para cadeira de rodas 1 : 16

(a) max 12 seg. de 120cm ou 14 seg. de 100cm



rampa para cadeira de rodas 1 : 20

(a) max seg de 150cm

NBR 9050

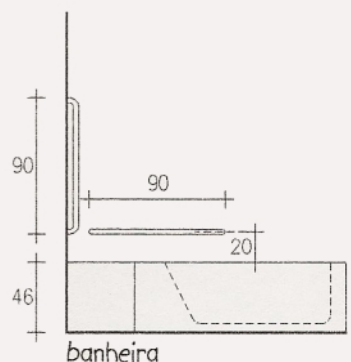
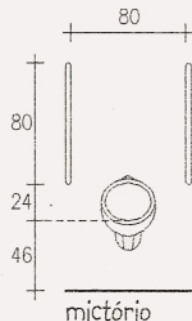
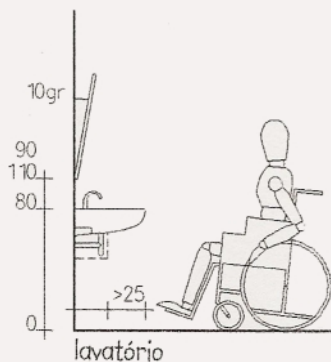
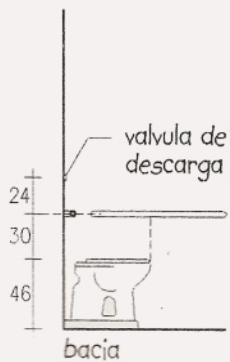
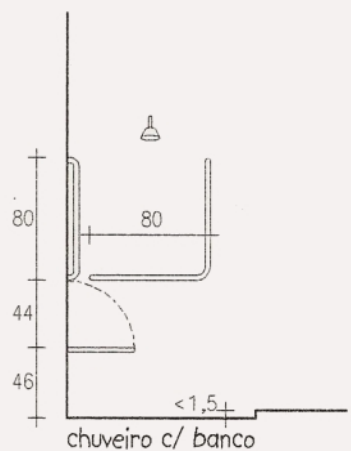
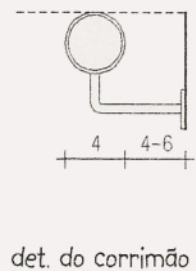
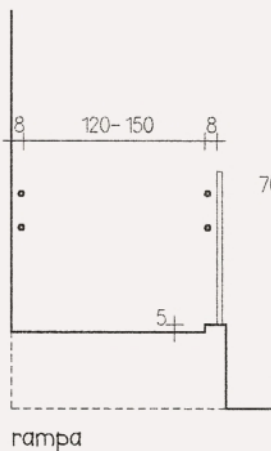
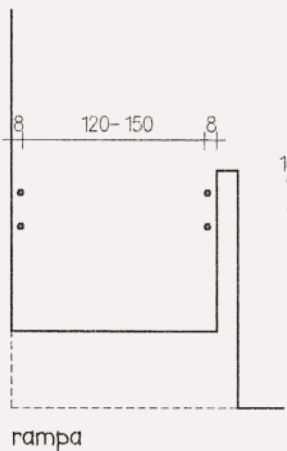
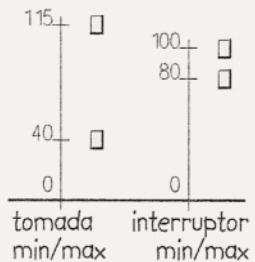
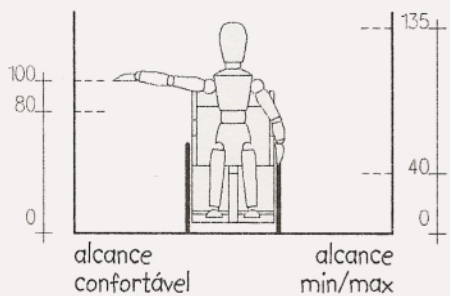

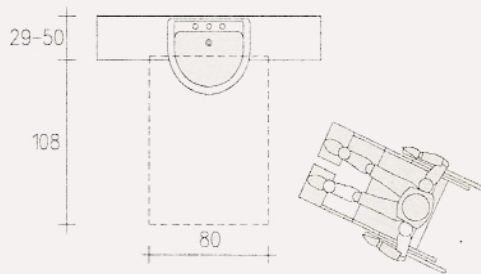
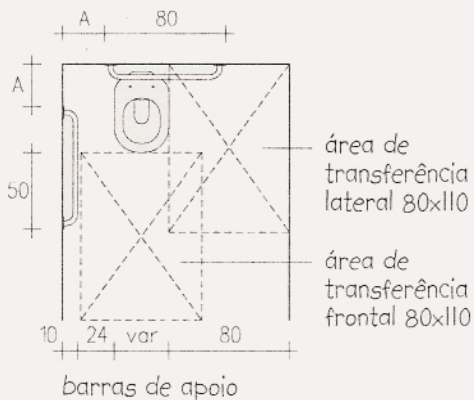

Deca L62

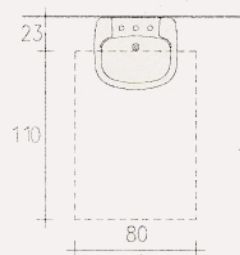

Deca L51+C51

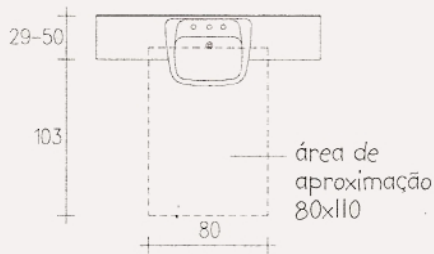
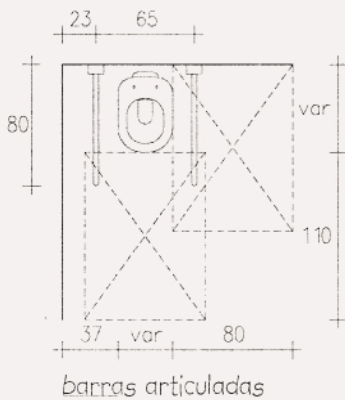

Deca L82

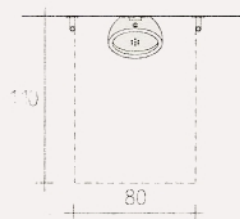

Deca M712

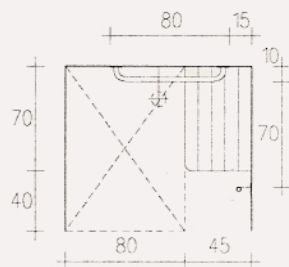
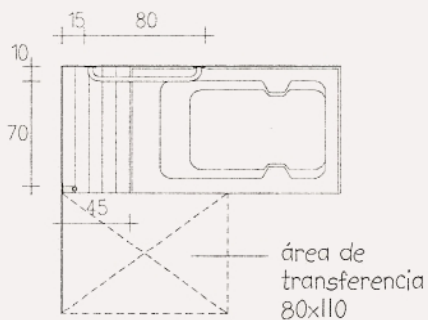

Peças Deca

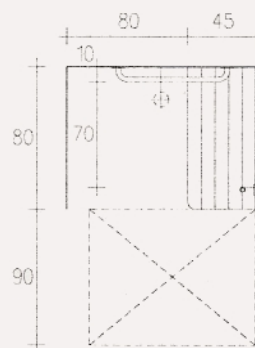

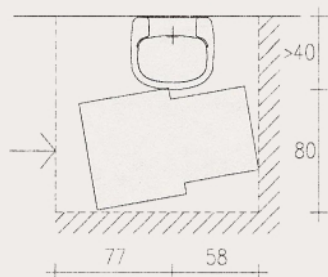

lavat. Deca L51+C51

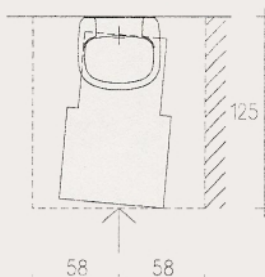

lavat. Deca L51+C51

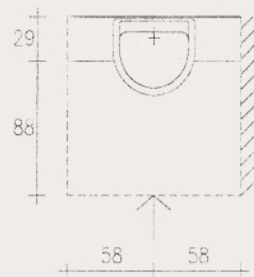

lavat. Deca L62

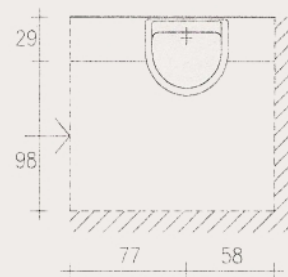

lavat. Deca L62

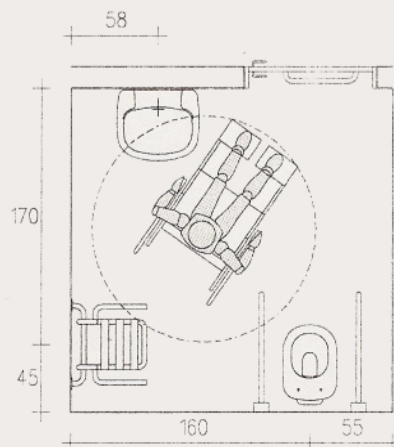
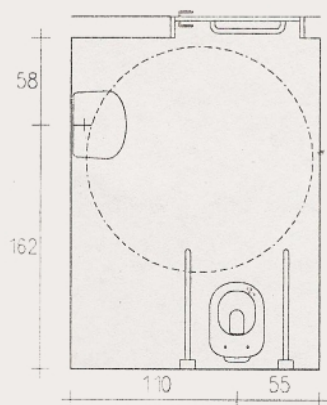
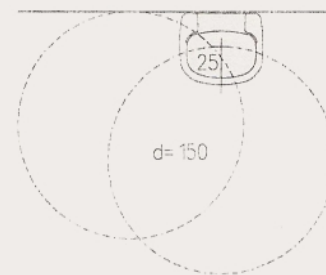
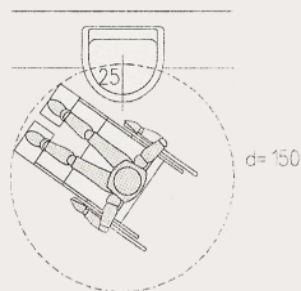
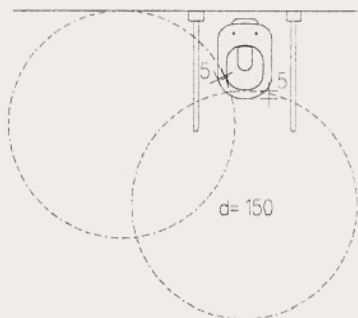

Peças Deca

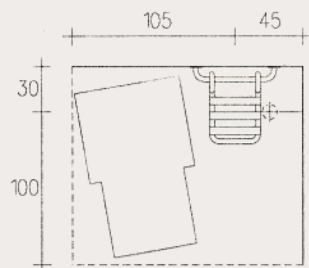

assento para chuveiro

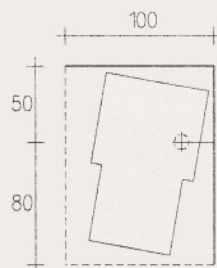

chuveiro

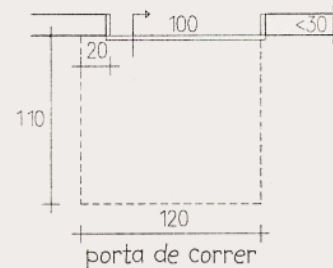

porta de correr

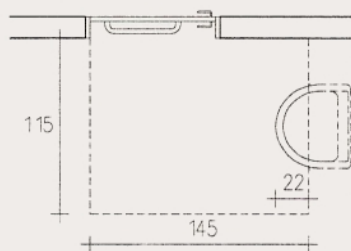

porta e lavatório

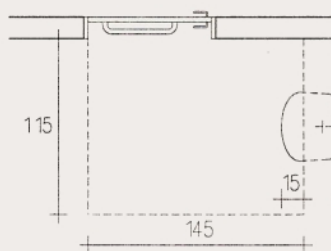

porta e lavatório

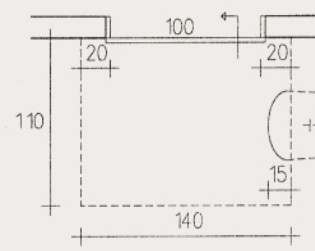

porta de correr e lavatório



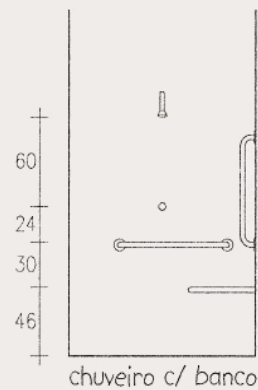
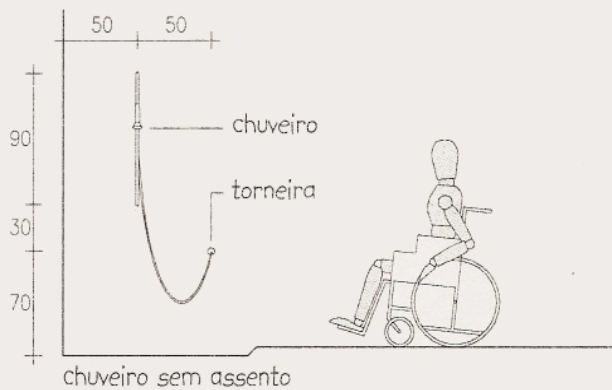
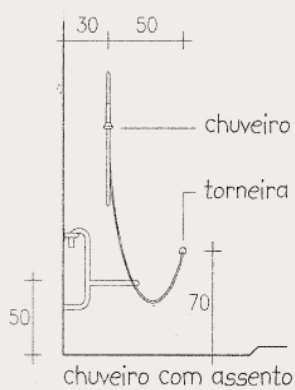
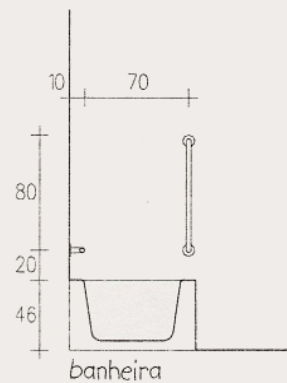
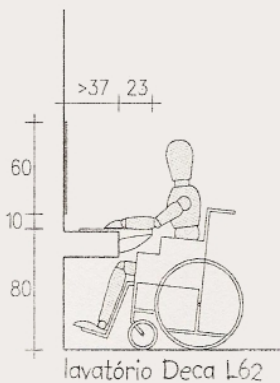
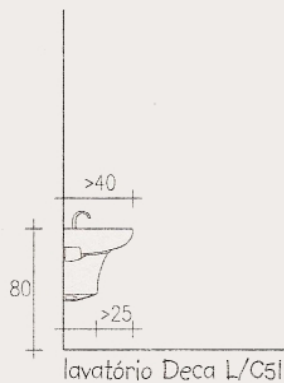
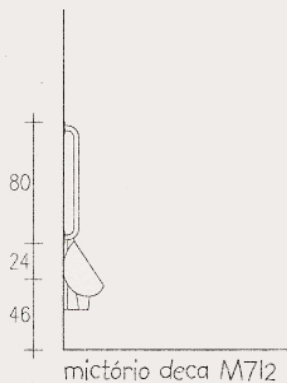
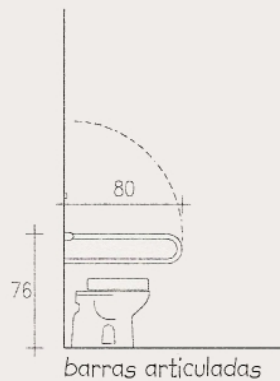
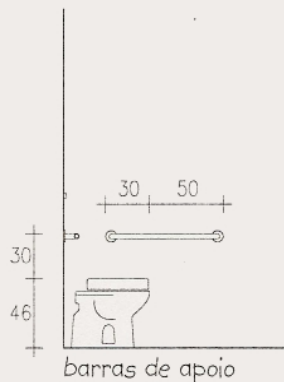
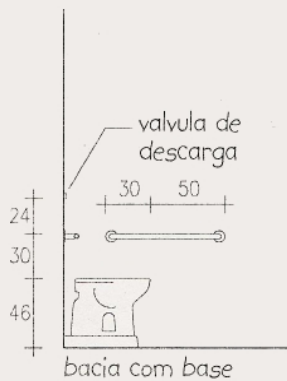

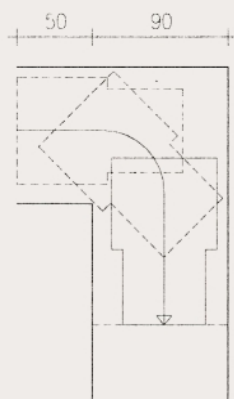

espaço mínimo  
p/ curva de 90gr

espaço mínimo  
p/ giro de 90gr

espaço mínimo  
necessário p/  
passagem por  
portas de correr

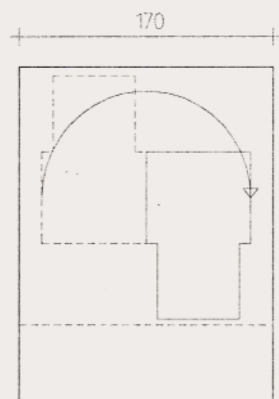
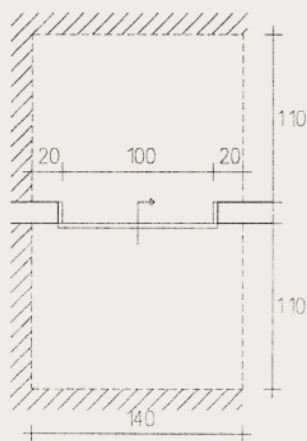

espaço mínimo p/ giro  
de 90gr ficando uma  
roda em ponto fixo

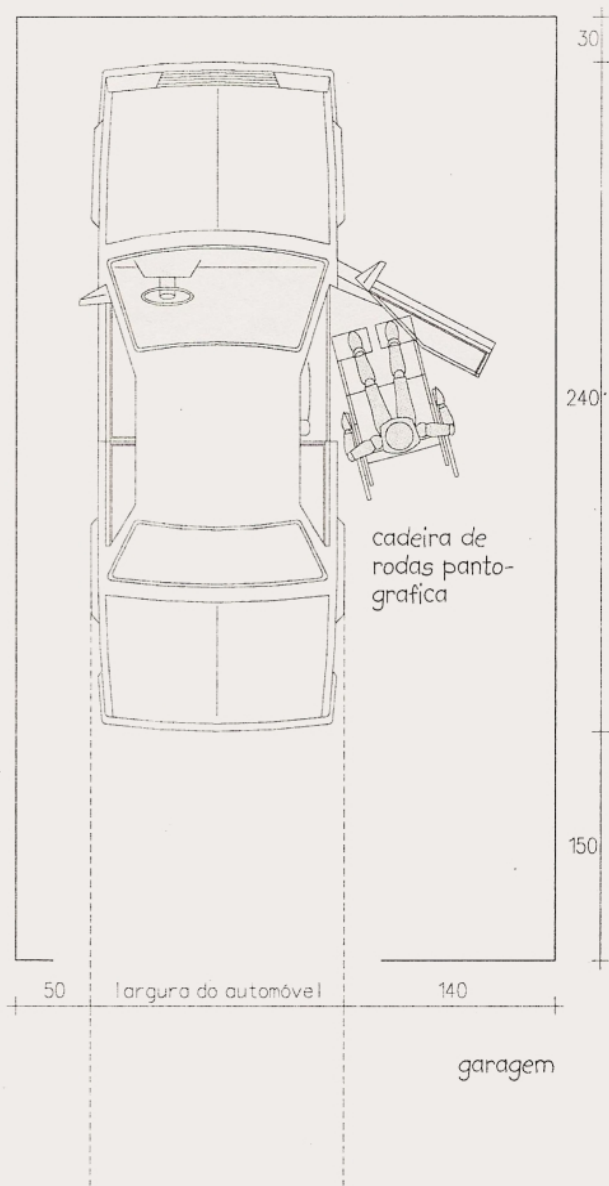
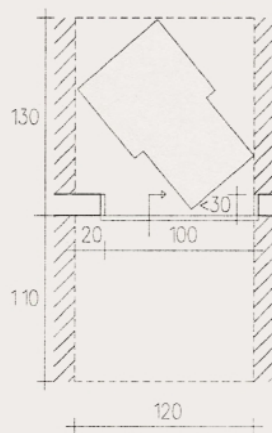
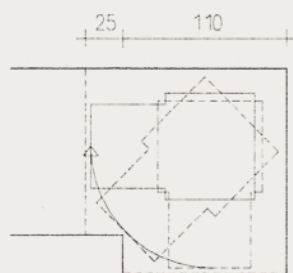

Adaptações Diversas

## Adaptações Diversas

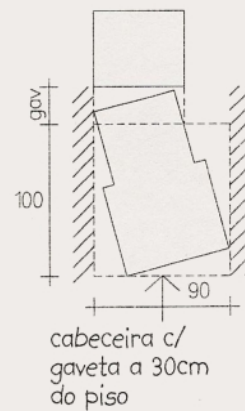
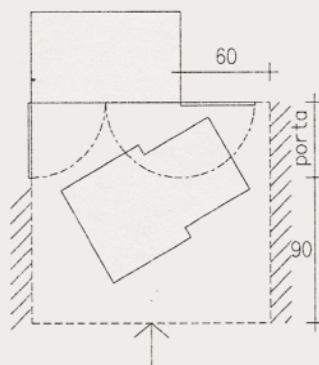
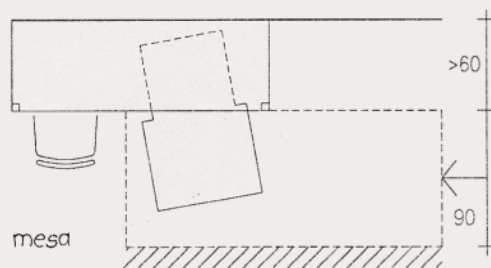
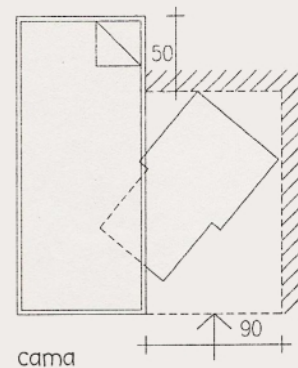
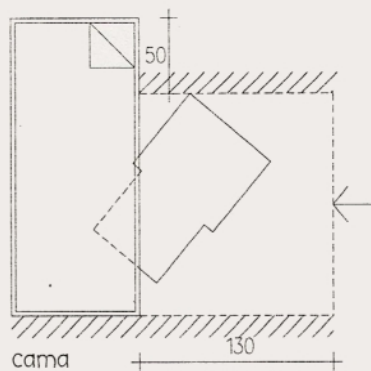
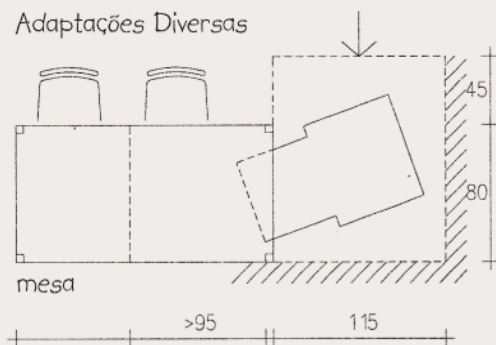

espaços mínimos necessários  
p/ o movimento da cadeira de  
rodas  
(→ = sentido da aproximação)

guarda-roupas  
e armários

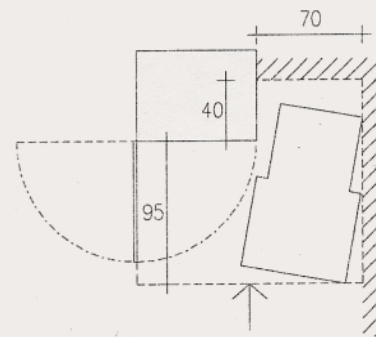
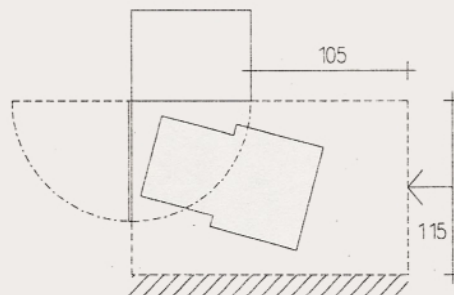
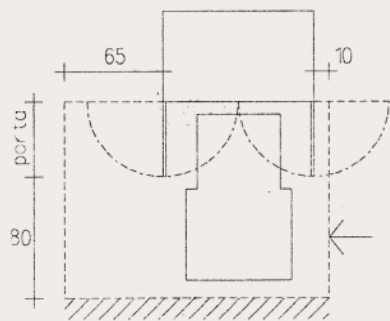

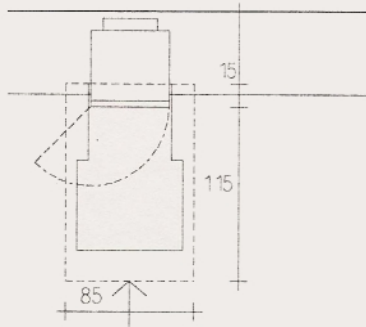

geladeira baixa  
(a 30cm livre do piso)

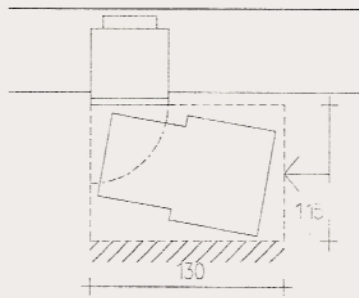

geladeira alta  
(a 70cm livre do piso)

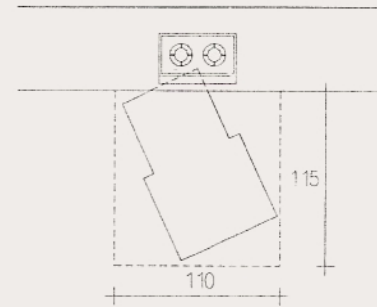

fogão  
(a 70cm livre do piso)

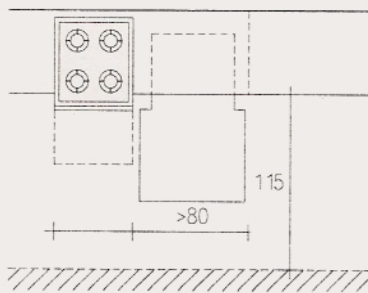

fogão c/ forno

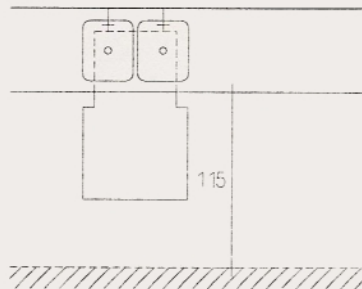

balcão e pia de cozinha  
(a 70cm livre do piso)

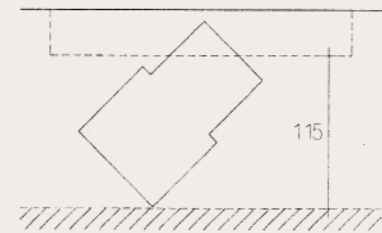

armário  
(a 70cm livre do piso)

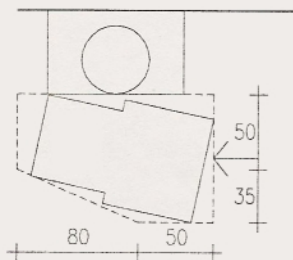

centrifuga, sexto de  
roupas e maq. de lav.

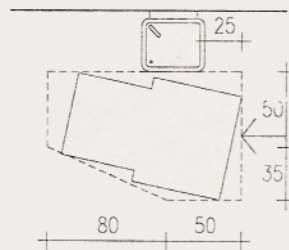

bebedouro

Adaptações Diversas

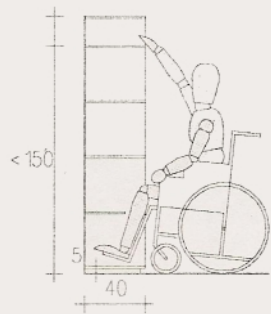

armário

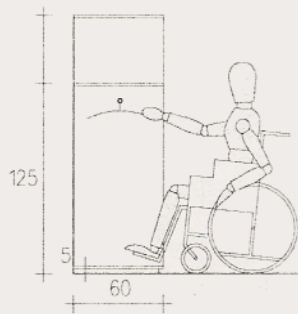

guarda-roupas

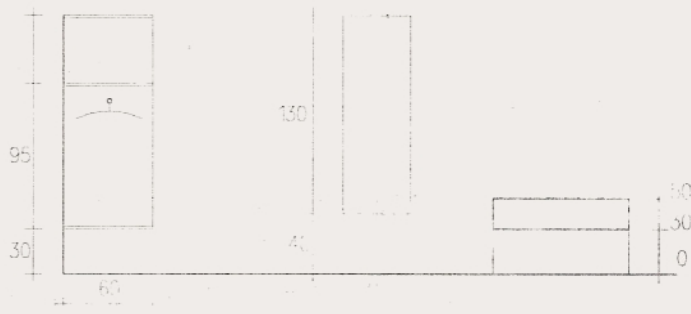

espelho

cama

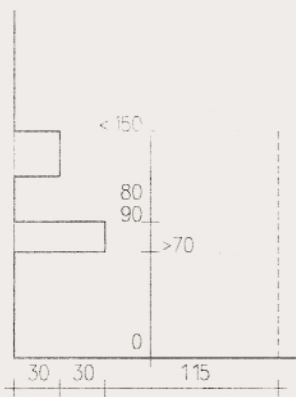

balcão c/ cuba e armários

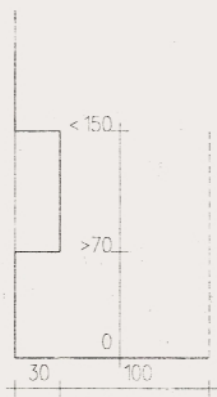

armários

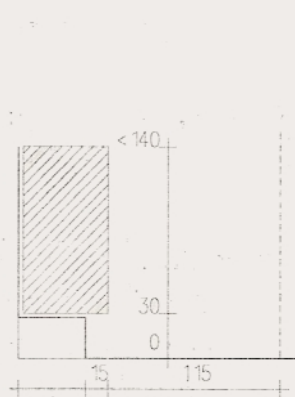

refrigerador

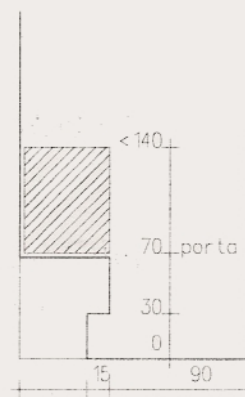

refrigerador ou forno

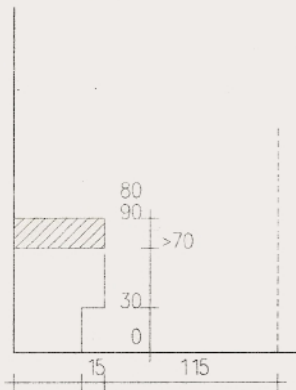

fogão

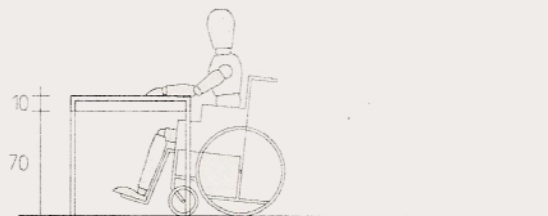

mesa

Adaptações Diversas

## Bibliografia

Harmen de Jong, Stoelen, Delft 1974.

A.J.H. Haak en D. Lever van der Burgh,  
De Menselijke Maat, Delft.

Geboden Toegang, Utrecht, 10e druk 1990.

Jan Sliwa and Leslie Fairweather, AJ Metric Handbook  
The Architectural Press - London 1976.

NBR 9050 - Acessibilidade de pessoas portadores de  
deficiência a edificações, espaço mobiliário  
e equipamentos urbanos,  
Rio de Janeiro, 1994.

Orientações para Projeto de Banheiros para  
Portadores de Deficiência Física - Deca - outubro 1998.

---



---

**Esta obra foi impressa nas oficinas da  
Editora Universitaria da Paraíba/UEPB**







ISBN - 85-237-0269-5



9 788523 702694